



XBee

Drop-in-Networking Accessories User Guide

User Guide

XBee Drop-in-Networking Accessories User's Guide

90000891

Revision	Date	Description
H	May 2014	Clarified the max voltage reading on the XBee sensors.
I	N/A	Revision I is not used.
J	February 2015	Editorial changes. Added warranty information.
K	March 2016	Updated references to Device Cloud. Corrected broken links.
L	June 2017	Modified regulatory and certification information as required by RED (Radio Equipment Directive).

Trademarks and copyright

Digi, Digi International, and the Digi logo are trademarks or registered trademarks in the United States and other countries worldwide. All other trademarks mentioned in this document are the property of their respective owners.

© 2017 Digi International. All rights reserved.

Disclaimers

Information in this document is subject to change without notice and does not represent a commitment on the part of Digi International. Digi provides this document “as is,” without warranty of any kind, expressed or implied, including, but not limited to, the implied warranties of fitness or merchantability for a particular purpose. Digi may make improvements and/or changes in this manual or in the product(s) and/or the program(s) described in this manual at any time.

Warranty

To view product warranties online, visit www.digi.com/howtobuy/terms.

Send comments

Documentation feedback: To provide feedback on this document, send your comments to techcomm@digi.com.

Customer support

Digi Technical Support: Digi offers multiple technical support plans and service packages to help our customers get the most out of their Digi product. For information on Technical Support plans and pricing, contact us at +1 952.912.3456 or visit www.digi.com/support.

Contents

General information

About this guide	6
Additional product information and resources	6
Hardware changes between 9-30V and 3.7-6V Adapter models	7
Powering options for adapters	7
Antenna considerations	8
Product compatibility and differences among XBee RF protocols	8

XBee RS-232 Adapter

Overview of the XBee RS-232 Adapter	19
Connection and power for the XBee RS-232 Adapter	20
Pinouts in the XBee RS-232 Adapter	20
Software programming and data retrieval	20
LEDs and buttons	21

XBee RS-485 Adapter

Overview of the XBee RS-485 Adapter	22
Connection and power for the XBee RS-485 Adapter	22
Pinouts of the XBee RS-485 Adapter	23
DIP switches	24
Software programming and data retrieval	24
LEDs and buttons	24

XBee Analog Adapter

Overview of the XBee Analog Adapter	26
Deployment decisions for the XBee Analog Adapter	27
Connection and power for the XBee Analog Adapter	27
XBee Analog Adapter pinouts	28
XBee Analog Adapter DIP switches	28
Configuration, software programming, and data retrieval in the XBee Analog Adapter	29
Input specifications and characteristics	30
Power output specifications for the XBee Analog Adapter	30
XBee Analog Adapter LEDs and buttons	31

XBee Digital I/O Adapter

Overview of the XBee Digital I/O Adapter	32
Deployment decisions for the XBee Digital I/O Adapter	33
Connection and power for the XBee Digital I/O Adapter	33
XBee Digital I/O Adapter pinouts	34
XBee Digital I/O Adapter DIP switches	35
Configuring inputs and outputs for the XBee Digital I/O Adapter	35
Software programming and data retrieval for the XBee Digital I/O Adapter	37
LEDs and buttons on the XBee Digital I/O Adapter	37

XBee USB Adapter

Overview of the XBee USB Adapter	39
Power requirements of the XBee USB Adapter	39
Download and install device driver for the XBee USB Adapter	39
Software programming and data retrieval for the XBee USB Adapter	40
XBee USB Adapter LEDs and buttons	40

XBee Sensor Adapter

Overview of the XBee Sensor Adapter	41
Available sensor products	41
Power options for the XBee sensor adapter	42
XBee Sensor Adapter placement recommendations	42
Connection and power for the XBee Sensor Adapter	42
XBee Sensor Adapter pinouts	42
Software programming and data retrieval for the XBee Sensor Adapter	43
XBee Sensor Adapter LEDs and buttons	43

XStick

Overview of the XStick	45
Power requirements for the XStick	45
Connection and startup of the XStick	45
Download and install device driver for the XStick	45
Software programming and data retrieval for the XStick	46
Unsupported XBee AT Commands for the XStick	46
XStick LEDs and buttons	46

XBee Wall Router / Smart Energy Range Extender

Overview of the XBee Wall Router/Smart Energy Range Extender	47
Placement recommendations for the XBee Wall Router	48
XBee Wall Router light and temperature sensors	48
Connection and startup for the XBee Wall Router	48
Connection and startup for the Smart Energy Range Extender	48
Operating the Smart Energy Range Extender	48
Software Programming and data retrieval for the XBee Wall Router and the Smart Energy Range Extender	49
LEDs, buttons, and integrated sensors	49

XBee Smart Plug

Overview of the XBee Smart Plug	51
XBee Smart Plug safety information	52
XBee Smart Plug connection and startup	53
XBee Smart Plug operation	54
Software programming and data retrieval	55

XBee sensors

Overview of XBee sensors	56
XBee sensor options	56
XBee sensor siting recommendations	57
Connection and power for XBee Sensors	57
Software programming and data retrieval for XBee Sensors	57

Sleep current in XBee Sensors	57
XBee Sensors LEDs, buttons, and integrated sensors	58
Configure XBee RF module settings	
Configuration with a Digi Gateway	59
Configuration without a Gateway	62
Hardware specifications	
XBee Adapters	64
XStick 802.15.4 (XStick1)	66
XStick ZigBee (XStick2)	67
XBee Wall Router / Smart Energy Range Extender	68
XBee Smart Plug	70
Integrated sensors for XBee Smart Plug	71
XBee sensors	71
Integrated sensors for XBee Sensors	72
Sleep current	73
Safety statements	
Class I division 2, groups A, B, C, D hazardous location	74
Lithium battery safety precaution	74
XBee Smart Plug installation safety	74

General information

This section includes information that applies to all XBee® Drop-in Networking Accessories.

About this guide

This guide describes the features and functions of all XBee Drop-in Networking Accessories for all XBee module protocols, including adapters, routers, sensors, and associated products.

It includes connection and setup information, pinouts, configuration, data retrieval, and LEDs and buttons.

Software programming for XBee Drop-in Networking Accessories is covered on product pages within the Digi Developer Community Wiki; see below for more information and location of these pages.

Additional product information and resources

Product data sheets, user's guides, and product manuals

Locate more information, including datasheets, XBee product manuals, Digi gateway product information, as well as other information, on the following page:

www.digi.com/products/gateways/

Software development resources

Digi provides several resources to help you get started developing software solutions in Python:

Digi Developer Community wiki

The Digi Developer Community Wiki is a place to learn about developing solutions using Digi's communications portfolio, software and services, including Python, Device Cloud and more.

www.digi.com/wiki/developer/index.php/Main_Page

Each product's chapter shows the link to the Wiki page for programming the product. For an index page for all XBee Drop-in Networking Accessories, go to:

www.digi.com/wiki/developer/index.php/Category:Drop-in_Networking_Products

Digi Python Custom Development Environment Page

Python is a dynamic, object-oriented language for developing software applications, from simple programs to complex embedded applications. You can use Python to obtain data from attached and integrated sensors on XBee Drop-in Networking Accessories. Find this page at:

www.digi.com/technology/drop-in-networking/python.jsp

Digi Python Programming Guide

This guide introduces the Python programming language by showing how to create and run a simple Python program. It reviews Python modules, particularly modules with Digi-specific behavior. It describes how to load and run Python programs onto Digi devices, either through the command-line or web user interfaces, and how to run several sample Python programs. Find this guide at the Digi Python Wiki page--in the **Start Here** section, click the link titled **Digi Python Programmer's Guide**

www.digi.com/wiki/developer/index.php/Python_Wiki

Python Support Forum on digi.com

Find answers to common questions and exchange ideas and examples with other members of the Digi Python development community at:

www.digi.com/support/forum/

Hardware changes between 9-30V and 3.7-6V Adapter models

XBee Adapters have undergone some hardware changes since first being launched. Most of these changes are minor and will have no impact on your application. However, one important difference relates to supply voltage.

Originally, XBee Adapters were designed to accept 9-30VDC. In an effort to improve battery performance, this voltage range has been changed to 3.7-6 VDC.

Power supplies used on 9-30VDC XBee Adapters will not work with 3.7-6VDC XBee Adapters, and vice versa. Your XBee Adapter's proper voltage is printed next to its power port.



CAUTION! Plugging in a power supply with the incorrect voltage will damage your device and void your warranty.

Several other changes have been implemented in the 3.7-6VDC XBee Adapter models, including an improved screw-lock connector for XBee RS-485, XBee Digital I/O, and XBee Analog I/O Adapters, and external antennas for XBee-PRO Adapters. Contact [Technical Support](#) for more details.

Powering options for adapters

Some Drop-in Networking Accessories, including the XBee Sensor, XBee Smart Plug and XBee Wall Router all have necessary powering options included.

XBee Adapter products can be powered by an external power supply or batteries, purchased separately. To determine how to power your XBee Adapter, please **refer to the specification printed on the side of the enclosure**, close to the power port:

Specification	Power Options
3.7 to 6 VDC	<p>Power supply: must be rated 3.7 to 6 VDC.</p> <p>Digi part number for 5V power supply: XA-ACC-PS5-NR</p> <p>Battery: uses custom lithium battery pack; Digi part number: XA-ACC-CS-L</p> <p>Battery amp hours: 1650 mAh. Replacement batteries available for purchase; contact Digi at 952-912-3444.</p>
9 to 30 VDC	<p>Power supply: must be rated 9 to 30 VDC.</p> <p>Digi part number for 9V power supply: XA-ACC-PS</p> <p>Battery: uses quantity 3 of 1.5V “N-Cell” alkaline batteries (input power is automatically down-converted).</p> <p>Use standard, off-the-shelf, batteries, or Digi part number: XA-ACC-BATT</p> <p>To install batteries, insert a screwdriver in the slots in the side of the adapter case and twist to snap off the cover. Insert the batteries following the polarity diagram on the board.</p>

For additional information, see the Power requirements rows in the table: [XBee Adapters](#) on page 64.

Warranty exception for batteries

Some XBee Drop-in Networking Accessories ship with alkaline batteries that must be replaced by the user when discharged.

Lithium batteries must be installed or replaced by qualified service personnel.

Alkaline and lithium batteries are not covered under the terms and conditions of the Digi warranty.

Antenna considerations

Products with external antennas should be mounted with the antenna oriented vertically to maximize the range.

Products with external antennas use RPSMA antenna connectors.

Products without external antennas can be mounted in any orientation.

Product compatibility and differences among XBee RF protocols

XBee Drop-in Networking Accessories contain an XBee or XBee-PRO module, an RF module that performs the wireless communications for your product. Certain RF module behaviors vary by XBee RF protocol. This section describes those differences and how they affect product operation.

Compatibility of accessories with other XBee products

Drop-in Networking Accessories that use a particular XBee RF protocol are compatible with other products of the same XBee RF protocol only. XBee ZB products will only work with other XBee ZB products, XBee 802.15.4 products with other XBee 802.15.4 products, and so on. This applies to gateways as well: ConnectPort X gateway products with an XBee ZB module are compatible with other such gateways, 802.15.4 gateways with other such gateways, and so on. Users must standardize on one XBee RF protocol series for operability.

Product support and availability by XBee RF protocol

Product availability varies by XBee RF protocol. The table shows the XBee Drop-in Networking Accessories available for each XBee platform.

Product / Protocol	XBee ZB	XBee ZNet2.5	XBee 802.15.4	XBee Smart Energy	XBee 868	XBee DigiMesh 900	XBee DigiMesh 2.4
XBee RS-232 Adapter	✓	✓	✓		✓	✓	✓
XBee RS-485 Adapter	✓	✓	✓		✓	✓	✓
XBee Analog Adapter	✓	✓	✓		✓	✓	✓
XBee Digital I/O Adapter	✓	✓	✓		✓	✓	✓
XBee USB Adapter	✓	✓				✓	✓
XStick	✓	✓	✓				
XBee Wall Router	✓	✓					
XBee Smart Energy Range Extender				✓			
XBee Smart Plug	✓	✓					
XBee Sensors	✓	✓					

Note New customer deployments should not use the ZNet 2.5 protocol. Instead, use the ZigBee-certified ZB protocol. ZNet, an older protocol based on a “Designed for ZigBee” stack, should only be used where required for compatibility with previously deployed ZNet 2.5 products.

XBee-PRO 868 availability

This product is end-of-life and is not for new design.

Firmware updates for XBee adapters and routers

The following table illustrates firmware update options by adapter type.

Adapter	Firmware Update?
USB Adapter	Allowed
XStick	Allowed
RS-232 Adapter	Allowed
RS-485 Adapter	Not allowed
Analog Adapter	Not allowed

Adapter	Firmware Update?
Digital I/O Adapter	Not allowed
XBee Wall Router	Allowed with programming cable
XBee Smart Energy Range Extender	Allowed with programming cable
XBee Smart Plug	Allowed with programming cable

ZB Adapters allow over-the-air (OTA) firmware updates. The firmware for other adapter types must be updated locally.

Idle current and sleep current - XBee and XBee-PRO

The following tables list the average expected idle and sleep currents for XBee adapters, based on type and network protocol. The first table shows XBee sleep current values, the second table shows XBee-PRO sleep current values. If an adapter is not listed here, it does not support sleep.

XBee Product / Protocol	XBee DigiMesh 2.4
RS-232 Adapter	72uA idle 230uA sleep
RS-485 Adapter	56uA idle 76uA sleep

XBee-PRO Product / Protocol	XBee-PRO DigiMesh 900	XBee-PRO DigiMesh 2.4
RS-232 Adapter	74uA idle 68mA sleep	75uA idle 287uA sleep
RS-485 Adapter	69uA idle 78uA sleep	58uA idle 140uA sleep
Digital I/O Adapter	57uA idle 108uA sleep	57uA idle 108uA sleep

XBee Adapters network association status

The Associate LED (occasionally abbreviated as Assc or Assoc) indicates the network association status for an XBee Drop-in Networking Accessory in an XBee network.

XBee ZB / XBee ZNet 2.5

If your network requires a coordinator device, the Associate LED indicates network association status in the following manner:

LED state	Network association
On, solid green	Not associated
On, blinking green	Successfully joined

XBee SE

If you are using products in a Smart Energy network, the Associate LED indicates network association status as follows:

LED state	Network association
On, solid green	Successfully joined
On, blinking green	Not joined, joining, or joined but connection invalid

Smart Energy Range Extender

The Smart Energy Range Extender's Associate LED indicates its join status; once joined, the LED also indicates the status of the adapter's connection to the network's Coordinator.

LED state	Network association
LED state	Network association
On, solid green	Joined, connection to Coordinator is working
On, 3 sec blink	Not joined, AI register indicates why
On, 1 sec blink	Trying to join
On, 1/4 sec blink	Joined, but connection to Coordinator is not working

XBee 802.15.4 / XBee 868

In networks that do not use a coordinator device for association, products are configured with a default PAN ID and destination address. On power-up, these products immediately indicate association by blinking to maintain LED consistency.

For more information regarding association options, see the manual for the XBee module in your product.

XBee DigiMesh 900 / XBee DigiMesh2.4

Products that have been configured in a synchronous sleep-compatible mode use the Associate LED to indicate the status of the node's synchronization with the sleeping network. Products that are not configured for sleep use the Associate LED to indicate that they are operating properly.

Synchronous sleep compatible?	LED state	Meaning
No	On, blinking green	Product is powered and operating properly.
Yes	On, solid green	Product has not synchronized with the network or has lost synchronization with the network.
Yes	On, slow blinking green (500 mSec blink time)	Product is acting as the network sleep coordinator and is operating properly.
Yes	On, fast blinking green (250 mSec blink time)	Product is properly synchronized with the network.

Commissioning and identity behaviors

The Ident button (or on some products, a combined Reset/Ident button) performs multiple functions to identify and configure the product in an XBee network. The location of this button is shown in each product's chapter.

Button presses and actions for each XBee RF protocol vary as shown in the following tables. These descriptions introduce XBee module concepts and commands. For additional information on these concepts and commands, see the product manual for your XBee module.

Consecutive button presses must occur within 800 milliseconds of each other to perform the desired action.

Note For more detailed descriptions and configuration information, see the CB command description in the XBee/XBee-PRO OEM Product manual for your particular module.

XBee SE

Number of button presses	Network association	Action
1	Associated	If the XBee module is asleep and associated with a network, pressing the button once wakes the unit for 30 seconds.
	Unassociated	If the unit is unassociated, one press starts the join process. Module will attempt to join a network three times before giving up. AI reading will indicate either joining success (0x00) or a reason for failure (nonzero value). See the AI command description in the product manual of your particular XBee module for more details.
2	Associated	If the unit is associated to a network, two button presses will cause it to broadcast a permit join message to the coordinator and all routers in the network. Permit join persists on a module for NJ time. See the NJ command description in the product manual for your particular XBee module for more details.
	Unassociated	If the unit is unassociated, there is no action.
4	Associated	If associated to a network, four button presses will cause the unit to broadcast a Leave notification to the network, then leave the network. It also restores the module to its EEPROM configuration values, except for the XBee Smart Energy Wall Router, which does not restore values.
	Unassociated	If the unit is unassociated, four presses restores the module to its EEPROM configuration values, except for the XBee Smart Energy Wall Router, which does not restore values.

XBee ZB / XBee ZNet 2.5

Number of button presses	Network association	Action
1	Associated	If XBee module is asleep, wakes unit for 30 seconds. Sends a Node Identification broadcast transmission. All devices that receive this transmission will blink their Associate LED rapidly for 1 second. All API devices that receive this transmission will send a Node Identification frame out their universal asynchronous receiver/transmitter (UART) (API ID 0x95).
	Unassociated	If XBee module is asleep, wakes unit for 30 seconds, then blinks the AI code, a numeric error code on the Assc LED indicating the cause of join failure. 1 blink: Scan found no networks (PANs) to join. 2 blinks: Scan found no valid PANs based on current settings for SC (Scan Channel) and ID (PAN ID). 3 blinks: Valid coordinator or routers were found, but they are not allowing joining, because the permit join or NJ command expired. 7 blinks: Network joining attempt failed. 10 blinks: Coordinator Start attempt failed.
2	Associated	Depends on the setting for the permit join (NJ) command for the XBee module. If the XBee module's NJ command setting is less than 255, two button presses temporarily enable joining on the XBee module and on the entire XBee network for 1 minute. If joining is permanently enabled on a module (NJ = 255), joining remains permanently enabled, and two button presses have no effect.
4	Associated/ Unassociated	XBee module leaves PAN, if associated, and issues a factory reset to restore default parameters in the XBee module. For XBee ZNet 2.5, the default PAN ID is 0x234. For XBee ZB, the default PAN ID is 0 (join any network).
4, followed by reset	Associated/ Unassociated	XBee module restores to EEPROM values

XBee 802.15.4

Number of button presses	Network association	Action
1	Associated	Cannot wake module, but causes module to remain awake for 30 seconds if pressed when the module is awake. Sends a Node Identification broadcast transmission. All devices that receive this transmission will blink their Associate LED rapidly for 1 second.
	Unassociated	Blinks a numeric error code returned by the ATAI (Association Indication) command on the Assoc LED. The AI code indicates the cause of the join failure. See the 802.15.4 XBee Product Manual for descriptions of these codes. 1 blink: Active scan timeout. 2 blinks: Active scan found no PANs. 3 blinks: Active scan found PAN, but the Coordinator Allow Association bit is not set. 4 blinks: Active scan found a PAN, but Coordinator and End Device are not configured to support beacons. 5 blinks: Active scan found a PAN, but Coordinator ID (PAN ID) value does not match the ID of the End Device. 6 blinks: Active Scan found a PAN, but Coordinator CH (Channel) value does not match the CH of the End Device. 7 blinks: Energy scan timeout. 8 blinks: Coordinator start request failed. 9 blinks: Coordinator could not start due to invalid parameters. 10 blinks: Coordinator Realignment is in progress. 11 blinks: Association request not sent. 12 blinks: Association request timed out - no reply was received. 13 blinks: Association request had an invalid parameter. 14 blinks: Association request channel access failure - request was not transmitted - CCA failure. 15 blinks: Remote Coordinator did not send an ACK after Association Request was sent. 16 blinks: Remote Coordinator did not reply to the Association Request, but an ACK was received after sending the request. 17 blinks: reserved. 18 blinks: Sync-Loss - lost synchronization with a beaconing coordinator. 19 blinks: Disassociated - no longer associated to coordinator.
2	Associated	Not supported.
4	Associated/ Unassociated	Performs an ATRE command to reset the parameters in the XBee module.
4, followed by reset	Associated/ Unassociated	XBee module restores to EEPROM values

XBee DigiMesh 900 / XBee DigiMesh 2.4

Number of button presses	Sleep configuration and sync status	Action
1	Not configured for sleep	Immediately sends a Node Identification broadcast transmission. All devices that receive this transmission will blink their Associate LED rapidly for 1 second. All API devices that receive this transmission will send a Node Identification frame out their UART (API ID 0x95).
1	Configured for sleep	Wakes the module for 30 seconds, or until the entire network goes to sleep. Queues a Node Identification broadcast transmission to be sent at the beginning of the next network wake cycle. All devices that receive this transmission will blink their Associate LED rapidly for 1 second. All API devices that receive this transmission will send a Node Identification frame out their UART (API ID 0x95).
2	Not configured for sleep	Not supported.
2	Configured for sleep	Causes a node that is configured with sleeping router nomination enabled to immediately nominate itself as the network sleep coordinator. For more information on this action, see the description of the ATSO sleep options command in the product manual for your specific XBee module.
4	Either	Issues an ATRE command to restore module parameters to default values.
4, followed by reset	Either	XBee module restores to EEPROM values.

Waking DigiMesh 2.4 XBee modules

When attempting to wake an XBee DigiMesh2.4 module from sleep, you must hold down the commissioning button for up to two seconds before the module will wake up.

XBee 868

Number of button presses	Action
1	Immediately sends a Node Identification broadcast transmission. All devices that receive this transmission will blink their Associate LED rapidly for 1 second. All API devices that receive this transmission will send a Node Identification frame out their UART (API ID 0x95).
2	Not supported.
4	Issues an ATRE command to restore module parameters to default values.
4, followed by reset	XBee module restores to EEPROM values.

Power levels of XBee radios

The transmit power level (PL setting) varies among XBee RF protocols.

XBee ZB / XBee ZNet 2.5

XBee Module

Power level	Conducted power in dBm
Lowest (0)	-8 dBm
Low (1)	-4 dBm
Medium (2)	-2dBm
High (3)	0 dBm
Maximum (4)	+2dBm

XBee-PRO Module

XBee-PRO ZB and ZNet 2.5 modules have a fixed power level that cannot be changed.

Power variant	Fixed conducted power in dBm
North American	+17 dBm
International	+10 dBm

XBee-PRO modules for RS-485 and RS-232 adapters have the following transmit power level (PL setting):

Settings	Transmit power in dBm
Setting	Transmit power in dBm
Lowest (0)	+9 dBm
Low (1)	+12 dBm
Medium (2)	+14 dBm
High (3)	+16 dBm
Maximum (4)	18 dBm

XBee 802.15.4

XBee Module

Power level	Conducted power in dBm
Lowest (0)	-10 dBm
Low (1)	-6 dBm
Medium (2)	-4 dBm
High (3)	-2 dBm
Maximum (4)	0 dBm

XBee-PRO Module

Power level	North American variant	International variant
Lowest (0)	+10 dBm	-3 dBm
Low (1)	+12 dBm	-3 dBm
Medium (2)	+14 dBm	+2 dBm
High (3)	+16 dBm	+8 dBm
Maximum (4)	+18 dBm	+10 dBm

XBee DigiMesh 900

The output power is always 17 dBm.

XBee 868

Power level	Conducted power in dBm
Lowest (0)	0 dBm
Low (1)	+13.7 dBm
Medium (2)	+20 dBm*
High (3)	+22 dBm**
Maximum (4)	+25 dBm
<p>* These products are currently set to not exceed this power setting:</p> <ul style="list-style-type: none"> XBee RS-232 Adapter XBee RS-485 Adapter XBee Analog I/O Adapter XBee Digital I/O Adapter <p>** XBee USB Adapter is currently set to not exceed this power setting.</p>	

XBee DigiMesh 2.4

XBee Module

Power level	Conducted power in dBm
Lowest (0)	-7 dBm
Low (1)	-1.7 dBm
Medium (2)	-0.77 dBm
High (3)	+0.62 dBm
Maximum (4)	+1.42 dBm

XBee-PRO Module

Power level	North American variant	International variant
Lowest (0)	+10 dBm	-3 dBm
Low (1)	+12 dBm	-3 dBm
Medium (2)	+14 dBm	+2 dBm
High (3)	+16 dBm	+8 dBm
Maximum (4)	+18 dBm	+10 dBm

Duty cycle for XBee 868 Module

The XBee 868 module has constraints regarding the amount of data it can transmit during a given time period. The duty cycle of this module is 10% averaged over the period of one hour. This means that if the next transmission will push the running average duty cycle over the 10% limit, the module will not transmit until enough time has elapsed to stay under the duty cycle. Because of heat restraints of the module, a 10% duty cycle over the period of one second will be enforced after the measured temperature of the module rises above 60°C.

XBee RS-232 Adapter

Overview of the XBee RS-232 Adapter



The XBee RS-232 Adapter provides short-range wireless connectivity to any RS-232 serial device. Unlike an embedded wireless module, which requires design integration and development time, these off-the-shelf adapters provide instant wireless connectivity to existing RS-232 serial devices. All XBee adapters can be used with Digi's ConnectPort X gateways for data aggregation and IP connectivity.

Connection and power for the XBee RS-232 Adapter

1. Connect the desired device to the RS-232 port of the adapter.
2. Connect the power supply to the adapter or insert batteries.

Pinouts in the XBee RS-232 Adapter

The RS-232 connector is an industry-standard DB9 male connector with a DTE configuration, similar to a PC serial port.

To connect the XBee RS232 Adapter to another DTE device, use a standard DB9 crossover serial cable similar to Digi part number 76000642.

To connect the adapter to a DCE device, use a straight-through null modem cable similar to Digi part number 63000066-01.

Pin 1 is in the leftmost pin on the upper row of pins; pin numbers increment from left to right, continuing left to right on the second row.

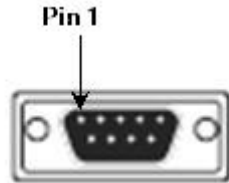

Pinouts for the connector are:

Pin	Function	Data direction
1	CD	Input
2	RXD	Input
3	TXD	Output
4	DTR	Output
5	GND	
6	DSR	Input
7	RTS	Output
8	CTS	Input
9	+12VDC switched power out	Output

Software programming and data retrieval

There are several avenues for programming the adapter.

To get started on developing solutions with the XBee RS-232 Adapter using Device Cloud, see the Device Cloud product page at www.digi.com/products/cloud/digi-device-cloud.

For details on programming the adapter and retrieving data from it, see the XBee RS-232 Adapter product page on the Digi Developer Community Wiki:

www.digi.com/wiki/developer/index.php/Category:Drop-in_Networking_Products

LEDs and buttons

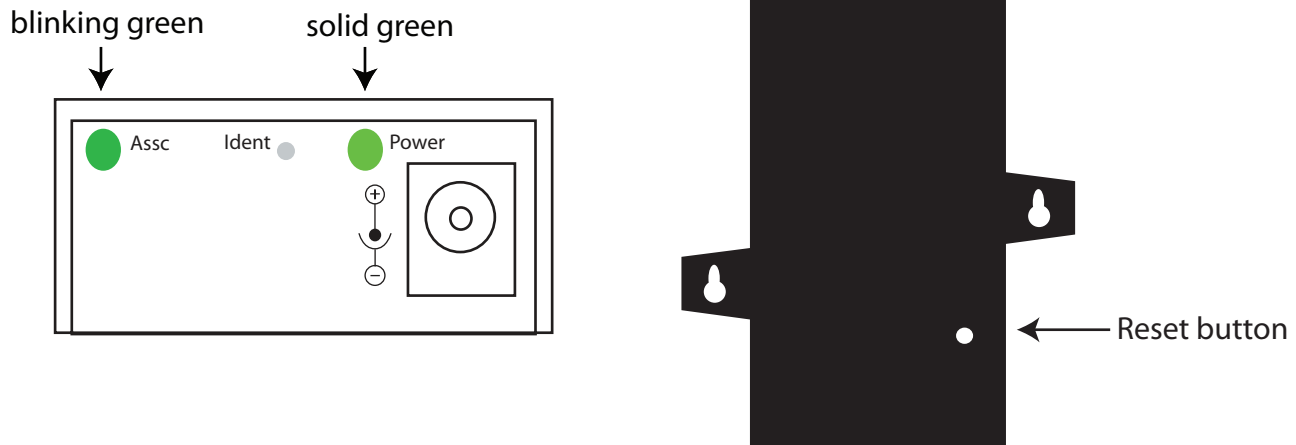

LED/Button	Function
Power LED	Indicates whether power is on. Illuminated only when adapter is connected to external power, not when powered by batteries. Not available in lithium-battery models.
Assc LED	Indicates the adapters' network association status. This LED functions differently depending on the XBee RF protocol for the product. See XBee Adapters network association status on page 10 for more information.
Reset Button	Recessed button on underside of the adapter. Performs equivalent of a power-cycle. Use a small non-conductive tool with a blunt end to press gently and hold down button.
Ident Button	Recessed button on power end of the adapter between Assc and Power LEDs. Performs multiple functions for identifying and configuring the adapter in a wireless network. Button presses and actions vary by XBee RF protocol; see Commissioning and identity behaviors on page 12. Consecutive button presses must occur within 800 milliseconds of each other to perform the desired action.

XBee RS-485 Adapter

Overview of the XBee RS-485 Adapter



The XBee RS-485 Adapter provides short-range wireless connectivity to any RS-485 serial device. Unlike an embedded wireless module, which requires design integration and development time, these off-the-shelf adapters provide instant wireless connectivity to existing RS-485 serial devices. All XBee adapters can be used with Digi's ConnectPort X gateways for data aggregation and IP connectivity.

Connection and power for the XBee RS-485 Adapter

1. Connect the desired device to the RS-485 port of the adapter.
2. Connect the power supply to the adapter or insert batteries.

Pinouts of the XBee RS-485 Adapter

The connector for the adapter is a 6-position wire terminal block. The figure shows Pin 1 of connector when the adapter is oriented with the mounting tabs, while viewing the underside of the adapter.

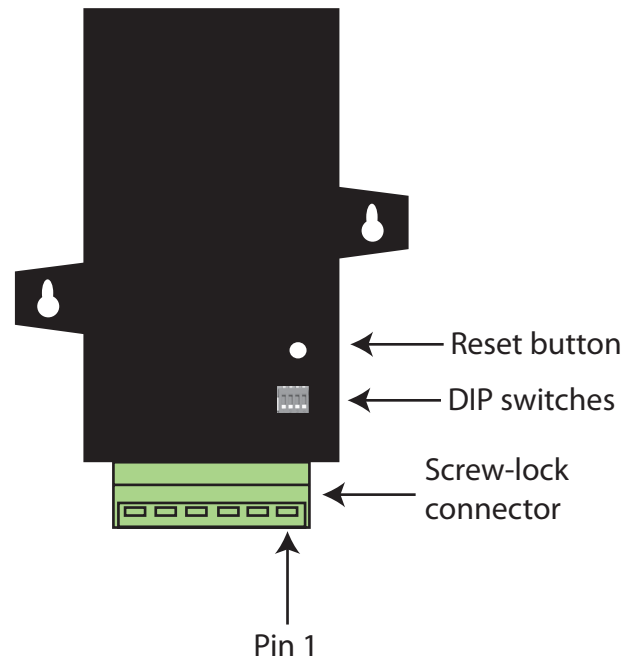

The adapter is switch-selectable between RS-422 half duplex/full duplex, and RS-485 modes (see [DIP switches](#) on page 24). The function for several pins varies between RS-422 and RS-485 modes.

Using the orientation in the above figure, pin 1 is the right-most pin and pin numbers increment from right to left. Pinouts for the connector are:

Pin	Function in RS-422 Mode	Function in RS-485 Mode
1	TxD+ (RS422)	TxD+ and RxD+ (RS485)
2	TxD- (RS422)	TxD- and RxD- (RS485)
3	RxD+ (RS422)	Not used.
4	RxD- (RS422)	Not used.
5	Ground	Ground
6	+12VDC 50mA max switched power out	+12VDC 50mA max switched power out

The connector accommodates wire gauges from 16AWG to 30AWG.

To insert wires, insert the wires into the removable screw-lock connector and tighten the screws associated with the wire slots.

To remove wires, loosen the screws associated with the wire slots and remove the wires.

DIP switches

The XBee RS-485 Adapter has several DIP switches on the underside of the unit. DIP switch 1 is the leftmost switch. When the adapter is oriented with the mounting tabs facing upwards, the DIP switches are in the ON position when the switches are positioned away from the screw-lock connector. Switch settings are:

DIP Switch	Switch settings
1	Not used. It is covered up by the case and is not accessible.
2, 3, 4 together	ON = RS485 OFF = RS422
5, 6 together	ON = RS485 bias and line termination on. OFF = RS485 bias and line termination off. Note You can only use the bias and line termination feature when you are powering the adapter from the external power supply.

Software programming and data retrieval

There are several avenues for programming the XBee RS-485 Adapter.

To get started on developing solutions with the XBee RS-485 Adapter using Device Cloud, see the Device Cloud product page at www.digi.com/products/cloud/digi-device-cloud.

For details on programming the XBee RS-485 Adapter and retrieving data from it, see the XBee RS-485 Adapter product page on the Digi Developer Community Wiki:

www.digi.com/wiki/developer/index.php/Category:Drop-in_Networking_Products

LEDs and buttons

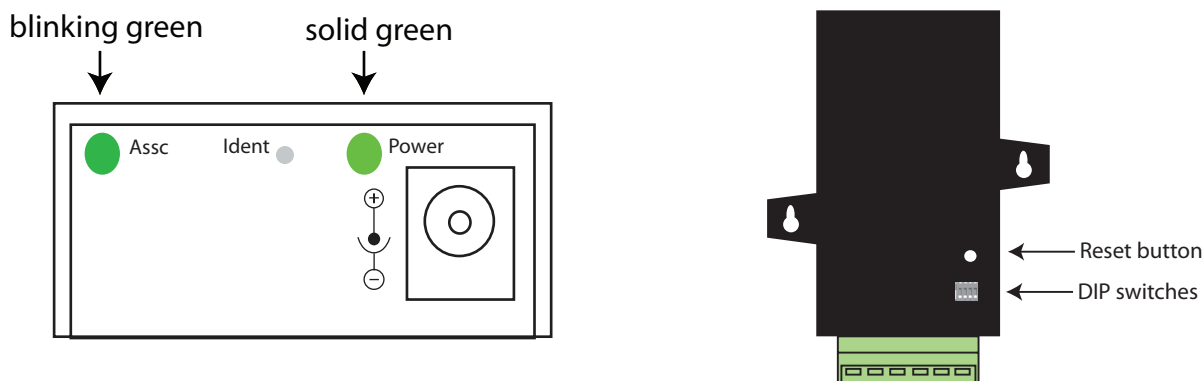

LED/Button	Function
Power LED	Indicates whether power is on. Illuminated only when adapter is connected to external power, not when powered by batteries. Not available in lithium-battery models.
Assc LED	Indicates the adapters' network association status. This LED functions differently depending on the XBee RF protocol for the product. See XBee Adapters network association status on page 10 for more information.
Reset button	Recessed button on underside of the adapter. Performs equivalent of a power-cycle. Use a small non-conductive tool with a blunt end to press gently and hold down button.
Ident button	Recessed button on power end of the adapter between Assc and Power LEDs. Performs multiple functions for identifying and configuring the adapter in a wireless network. Button presses and actions vary by XBee RF protocol; see Commissioning and identity behaviors on page 12. Consecutive button presses must occur within 800 milliseconds of each other to perform the desired action.

XBee Analog Adapter

Overview of the XBee Analog Adapter



The XBee Analog Adapter provides short-range wireless connectivity to any analog device. Unlike an embedded wireless module, which requires design integration and development time, this off-the-shelf adapter provides instant wireless connectivity to existing analog devices. All XBee adapters can be used with Digi's gateways for data aggregation and IP connectivity.

The XBee Analog adapter allows for several interfaces to analog devices. It provides greater flexibility and uses than XBee Sensors, in that it can be used with a variety of off-the-shelf sensor products and in situations when the item being measured or analyzed must be separated from the sensor/measuring device itself.

Deployment decisions for the XBee Analog Adapter

Deploying the XBee Analog Adapter in a solution involves answering several questions:

- What is the analog mode of the sensor you plan to attach to the adapter?
- How do you want to retrieve measurement data from the adapter?
- How will the adapter be powered? Mains or battery?

Analog modes of the XBee Analog Adapter

The XBee Analog Adapter has three modes in which it can measure input on its four terminal lines:

- **0-10 volt mode:** measures voltage on a scale of 0 to 10 volts, and translates it into a 10-bit scale from 0 to 1023 as possible values.
- **Current Loop (4 mA to 20 mA) mode:** measures amperage on a scale of 4 to 20 mA, and translates it into a 10-bit scale from 0 to 1023 as possible values.
- **Differential input mode:** measures paired terminals (1 and 2 paired, 3 and 4 paired) and translates the difference in voltage between the two lines into a 10-bit scale from 0 to 1023 as possible values.

Measurement retrieval options for the XBee Analog Adapter

There are several ways to retrieve data collected by the XBee module in the adapter:

- By using the Device Integration Application (DIA) framework. DIA is software that simplifies connecting devices (such as sensors and PLCs) to communication gateways. DIA includes a comprehensive library of plug-ins that work out-of-the-box with common device types and can also be extended to include new devices.
- By using existing Python modules provided by Digi.
- By using your own custom Python programs.
- By issuing remote AT commands from another XBee device.

Connection and power for the XBee Analog Adapter

1. Connect the wires for the desired analog device to the connector for the adapter. The connector accommodates wire gauges from 16AWG to 30AWG.

To connect the wires, insert the wires into the removable screw-lock connector and tighten the screws associated with the wire slots.

To remove the wires, loosen the screws associated with the wire slots and remove the wires.

The connector for the adapter is a 6-position wire terminal block. The figure shows Pin 1 of the connector when the adapter is oriented with the mounting tabs, when viewing the underside of the adapter.



2. Connect the power supply to the adapter or insert batteries.

XBee Analog Adapter pinouts

Using the orientation in the figure on the previous page, pin 1 is the right-most pin and pin numbers increment from right to left. Pinouts for the connector are:

Pin	Analog Mode		
	Ten Volt	Current Loop	Differential
1	0-10 Volt	4-20 mA	Terminal Pair 1 positive
2	0-10 Volt	4-20 mA	Terminal Pair 1 negative
3	0-10 Volt	4-20 mA	Terminal Pair 2 positive
4	0-10 Volt	4-20 mA	Terminal Pair 2 negative
5	Ground	Ground	Ground
6	+12VDC 50mA max switched power out	+12VDC 50mA max switched power out	+12VDC 50mA max switched power out

XBee Analog Adapter DIP switches

The adapter has several DIP switches on the underside of the unit. DIP switch 1 is the leftmost switch. When the adapter is oriented with the mounting tabs facing upwards, the DIP switches are in the ON position when the switches are positioned away from the screw-lock connector. Switch settings are:

DIP Switch	Switch settings
1	Enables and disables direct battery pack voltage output. ON=battery power out OFF=no battery power out
2	Enables and disables +12V power out. ON=+12V power out OFF=no +12V power out
3	Not used
4	Not used



CAUTION! Switches 1 and 2 should not be on at the same time as this causes parasitic battery drain.

Configuration, software programming, and data retrieval in the XBee Analog Adapter

There are several avenues for programming the adapter.

To get started on developing solutions with the adapter using Device Cloud, see the Device Cloud, see the Device Cloud product page at www.digi.com/products/cloud/digi-device-cloud.

For details on programming the adapter and retrieving data from it, see the XBee Analog Adapter product page on the Digi Developer Community Wiki:

www.digi.com/wiki/developer/index.php/Category:Drop-in_Networking_Products

Important: serial communications disabled on XBee Analog and Digital I/O Adapters

For the XBee Analog and Digital I/O Adapters, the XBee firmware disables the XBee module's serial communications functionality, so that the pins normally used for serial communications can instead be used for additional I/O functionality. As a result, once an XBee module has been loaded with the firmware image specific to the XBee Analog or Digital I/O Adapters, the XBee module can no longer be configured using XCTU, the XBee serial API, or local AT commands.

The only way to configure these adapters is by using the **Ident** or **Ident/Reset** commissioning and identification button (see [Commissioning and identity behaviors](#) on page 12 for description) and OTA commands. You can do this by using a ConnectPort gateway or XCTU, or by using the remote command API of another serial-enabled module associated to the same network.

Input specifications and characteristics

Analog Mode	Specification	Value
0-10 volt mode	Full-scale input	10.25 VDC
	Minimum input	0 VDC
	Maximum safe input	11VDC
	Minimum safe input	-.5VDC
	Input impedance	28200 Ω
Current Loop (4 mA to 20 mA) mode	Full-scale input	23.5mA
	Minimum input	0mA
	Maximum safe input	40mA
	Minimum safe input	-.5VDC
	Input impedance	51.1 Ω
+/- 2 VDC differential mode	Full-scale input	+2.4 VDC differential
	0V differential	Half-scale reading
	-2V differential	Minimum-scale reading
	Maximum safe input (each pin)	11VDC
	Minimum safe input (each pin)	-.5VDC
	Input impedance	~1 M Ω
All modes	Resolution	10 bits
	Accuracy	Differs by XBee RF protocol: XBee ZB, ZNet 2.5, 802.15.4: 0.2% XBee 868, DigiMesh 900: 0.4%



CAUTION! Exceeding the maximum or minimum safe input values will result in damage to the unit.

Power output specifications for the XBee Analog Adapter

External terminal 6 is a power-out pin. It can be set to either battery pack voltage out or +12VDC at 50mA out via DIP switches 1 and 2.

External terminal 5 is a system ground pin. This ground pin should be used for all external ground connections for both power and input connections.

DIP switch 1 enables battery pack voltage minus .5VDC to terminal 6, resulting in 4VDC out with new alkaline batteries, or 3.1VDC with new lithium battery.

DIP switch 2 enables +12VDC to terminal 6. Only one switch should be on at a time. No damage will happen if both are set to on, but the output will default to the +12VDC output and the result will be increased parasitic battery drain.

The battery pack voltage is on terminal 6 all the time, and is not gated with the sleep of the module when DIP switch 2 is on. Any current draw from terminal 6 will result in reduced battery life.

When DIP switch 2 is on, the +12VDC at 50mA max is provided at terminal 6. This power is gated by both the sleep of the module and AT command P3. For this power setting to be on, the XBee module needs to be awake and AT command P3 set to a high level.

XBee Analog Adapter LEDs and buttons

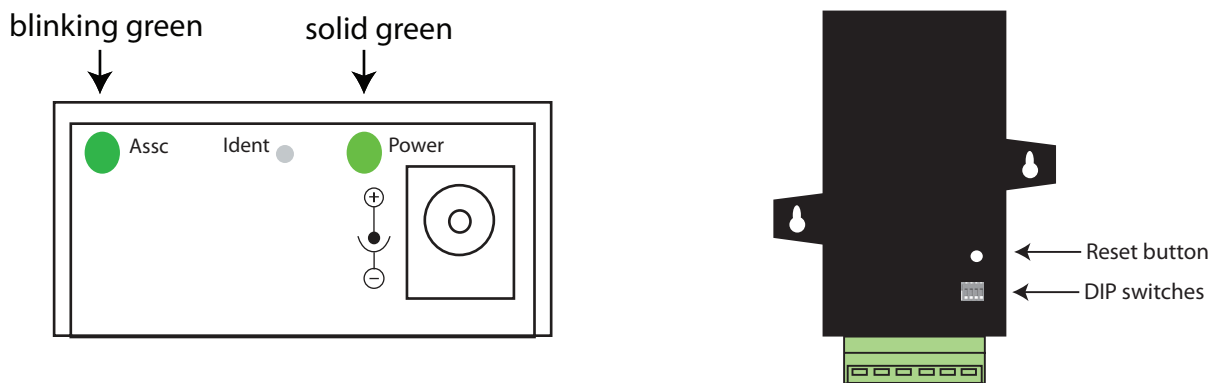

LED/Button	Function
Power LED	Indicates whether power is on. Illuminated only when adapter is connected to external power, not when powered by batteries. Not available in lithium-battery models.
Assc LED	Indicates the adapters' network association status. This LED functions differently depending on the XBee RF protocol for the product. See XBee Adapters network association status on page 10 for more information.
Reset Button	Recessed button on underside of the adapter. Performs equivalent of a power-cycle. Use a small non-conductive tool with a blunt end to press gently and hold down button.
Ident Button	Recessed button on power end of the adapter between Assc and Power LEDs. Performs multiple functions for identifying and configuring the adapter in a wireless network. Button presses and actions vary by XBee RF protocol; see Commissioning and identity behaviors on page 12. Consecutive button presses must occur within 800 milliseconds of each other to perform the desired action.

XBee Digital I/O Adapter

Overview of the XBee Digital I/O Adapter



The XBee Digital I/O Adapter provides short-range wireless connectivity to any digital device, as well as an interface to logic-level inputs and sinking driver output. Unlike an embedded wireless module, which requires design integration and development time, these off-the-shelf adapters provide instant wireless connectivity to existing digital devices. All XBee adapters can be used with Digi's gateways for data aggregation and IP connectivity.

Deployment decisions for the XBee Digital I/O Adapter

Deploying the XBee Digital I/O Adapter in a solution involves answering several questions:

- What types of conditions do you want to detect with the adapter and its attached sensor?
- Do you need the adapter to detect conditions from multiple sensors?
- Is there a need to have output from the adapter, and if so, what do you want it to do?
- How do you want to retrieve measurement data from the adapter?
- How do you want to power the adapter? Mains or battery?

Data retrieval options for the XBee Digital I/O Adapter

There are several ways to retrieve data collected by the XBee module in the adapter:

- By using the DIA framework. DIA is software that simplifies connecting devices (sensors, PLCs, etc.) to communication gateways. DIA includes a comprehensive library of plug-ins that work out-of-the-box with common device types and can also be extended to include new devices.
- By using existing Python modules provided by Digi.
- By using your own custom Python programs.
- By issuing remote AT commands from another XBee device.

Connection and power for the XBee Digital I/O Adapter

1. Connect the wires for the desired analog device to the connector for the adapter. The connector accommodates wire gauges from 16AWG to 30AWG.

To insert wires, insert the wires into the removable screw-lock connector and tighten the screws associated with the wire slots.

To remove wires, loosen the screws associated with the wire slots and remove the wires.

The connector for the adapter is a 6-position wire terminal block. The figure shows Pin 1 of the connector when the adapter is oriented with the mounting tabs, facing upwards (the underside of the adapter).

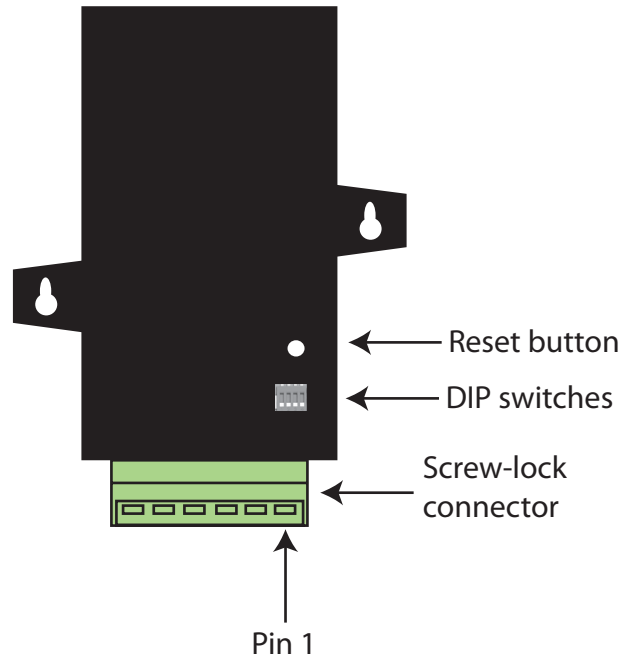

2. Connect the power supply to the adapter or insert batteries.

XBee Digital I/O Adapter pinouts

Using the orientation in the figure on the previous page, pin 1 is the right-most pin on the screw-lock connector, and pin numbers increment from right to left. Pinouts for the connector are:

Pin	Function
1	These pins are configurable as digital input or sinking driver output.
2	
3	
4	
5	GND
6	+12VDC 50mA max switched power out

XBee Digital I/O Adapter DIP switches

The adapter has several DIP switches on the underside of the unit. DIP switch 1 is the leftmost switch. When the adapter is oriented with the mounting tabs facing upwards, the DIP switches are in the ON position when the switches are positioned away from the screw-lock connector. Switch settings are:

DIP Switch	Switch settings
1	Enables and disables direct battery pack voltage output. ON = battery power out. OFF = no battery power out.
2	Enables and disables +12V power out. ON = +12V power out. OFF = no +12V power out.
3	Turns on 10K pullup on terminal 1 to 3VDC.
4	Turns on 10K pullup on terminal 2 to 3VDC.



CAUTION! Switches 1 and 2 should not be on at the same time, as it causes parasitic battery drain.



CAUTION! We do not recommend using pullups when running from battery power, due to the constant drain on the batteries.

Configuring inputs and outputs for the XBee Digital I/O Adapter

As shown in the pinouts table, the adapter has four external terminals that can be set as either a digital input or a sinking driver output.

The XBee module controls the sinking drivers on pins 11, 16, 12, 4 for terminals 1, 2, 3, 4 respectively.

The AT commands to the XBee module for the output function are D4, D6, D7, P2 for terminals 1, 2, 3, 4 respectively.

To activate the outputs and thus turning on the sinking function, set the corresponding XBee pin at high.

- To set a terminal high, set the corresponding AT command to value 5.
- To set a terminal low, set the corresponding AT command to value 4.

For example, calling the AT command D4 and setting it to 5 would cause terminal 1 to be set high.

Since the input and output functions overlap, the input function is always active and when the input function is desired, the output control pin for the matching output must be set low (turns off the sinking function). This feature can allow the inputs to monitor the output sinking operation if desired.

There are several resources to help you configure these inputs and outputs:

- DIA contains a device driver to handle this configuration automatically.
- There are sample Python programs for configuring inputs and outputs available on the [Digi Developer Community Wiki](#). See the Wiki for this sample code and different options for issuing the AT commands over-the-air.

Input/output specifications and characteristics for the XBee Digital I/O Adapter

Digital mode	Specification	Value
Digital Input	Input type	Non-inverting Schmitt trigger gate
	Positive-going switching threshold	~1.6 VDC
	Negative-going switching threshold	~1.0 VDC
	Maximum safe input	+30VDC
	Minimum safe input	-.5VDC
	Input impedance	~1.5 M Ω
	Default level when no input applied	Low
Digital Output	Output type	Open collector sinking driver
	Maximum sink current	1.8ADC
	Maximum off voltage	+30VDC
	Minimum safe input	-.5VDC
	Resistor pullups	10K Ω pulled up to 3VDC; switch-selectable



CAUTION! Exceeding the maximum or minimum safe input values will result in damage to the unit.

Power output specifications for the XBee Digital I/O Adapter

External terminal 6 is a power-out pin. It can be set to either battery pack voltage out or +12VDC at 50mA out via DIP switches 1 and 2.

External terminal 5 is a system ground pin. This ground pin should be used for all external ground connections for both power and input connections.

DIP switch 1 enables battery pack voltage minus .5VDC to terminal 6, resulting in 4VDC out with new alkaline batteries, or 3.1VDC with new lithium battery. DIP switch 2 enables +12VDC to terminal 6. Only one switch should be on at a time. No damage will happen if both are set to on, but the output will default to the +12VDC output and the result will be increased parasitic battery drain.

The battery pack voltage is on terminal 6 all the time and not gated with the sleep of the module when DIP switch 2 is on. Any current draw from terminal 6 will result in reduced battery life. This mode is primarily intended with switch closure applications with the adapter, with the external switch in the customer equipment in the normally open position, so that no battery current results until the activating event occurs.

When DIP switch 2 is on, the +12VDC at 50mA max is provided at terminal 6. This power is gated by both the sleep of the module and AT command P3. For this power setting to be on, the XBee module needs to be awake and AT command P3 set to a high level.

Software programming and data retrieval for the XBee Digital I/O Adapter

There are several avenues for programming the adapter.

To get started on developing solutions with the adapter using Device Cloud, see the Device Cloud, see the Device Cloud product page at www.digi.com/products/cloud/digi-device-cloud.

For details on programming the adapter and retrieving data from it, see the XBee Digital I/O Adapter product page on the Digi Developer Community Wiki:

www.digi.com/wiki/developer/index.php/Category:Drop-in_Networking_Products

Important: serial communications disabled on XBee Analog and Digital I/O Adapters

For the XBee Analog and Digital I/O Adapters, the XBee firmware disables the XBee module's serial communications functionality, so that the pins normally used for serial communications can instead be used for additional I/O functionality. As a result, once an XBee module has been loaded with the firmware image specific to the XBee Analog or Digital I/O Adapters, the XBee module can no longer be configured using XCTU, the XBee serial API, or local AT commands.

The only way to configure these adapters is by using the **Ident** or **Ident/Reset** commissioning and identification button (see [Commissioning and identity behaviors](#) on page 12 for description) and OTA commands. You can do so by using a ConnectPort gateway or XCTU, or by using the remote command API of another serial-enabled module associated to the same network.

LEDs and buttons on the XBee Digital I/O Adapter

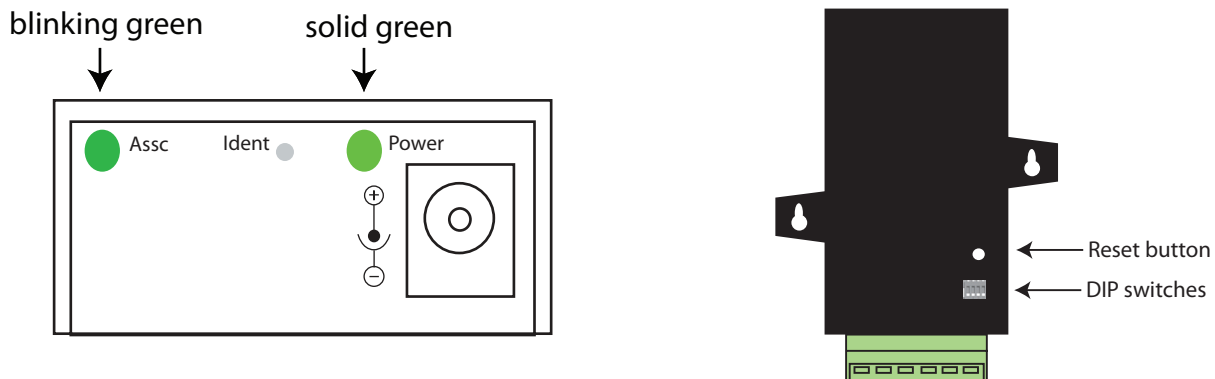

LED / Button	Function
Power LED	Indicates whether power is on. Illuminated only when adapter is connected to external power, not when powered by batteries. Not available in lithium-battery models.
Assc LED	Indicates the adapters' network association status. This LED functions differently depending on the XBee RF protocol for the product. See XBee Adapters network association status on page 10 for more information.
Reset button	Recessed button on underside of the adapter. Performs equivalent of a power-cycle. Use a small non-conductive tool with a blunt end to press gently and hold down button.
Ident button	<p>Recessed button on power end of the adapter between Assc and Power LEDs. Performs multiple functions for identifying and configuring the adapter in a wireless network. Button presses and actions vary by XBee RF protocol; see Commissioning and identity behaviors on page 12.</p> <p>Consecutive button presses must occur within 800 milliseconds of each other to perform the desired action.</p>

XBee USB Adapter

Overview of the XBee USB Adapter



The XBee USB Adapter provides short-range wireless connectivity to any USB device. Unlike an embedded wireless module, which requires design integration and development time, these off-the-shelf adapters provide instant wireless connectivity to existing USB devices. All XBee adapters can be used with Digi's gateways for data aggregation and IP connectivity

Power requirements of the XBee USB Adapter

The XBee USB Adapter is a bus-powered device.

Download and install device driver for the XBee USB Adapter

The XBee USB Adapter requires a device driver, **FT232R**. This device driver causes adapter device to appear as an additional COM port available to the PC. Application software can access the adapter in the same way as it would access a standard COM port.

To download this device driver, go to this web page and select the download appropriate for your operating system:

www.ftdichip.com/Drivers/VCP.htm

<http://www.ftdichip.com/Drivers/VCP.htm>

Software programming and data retrieval for the XBee USB Adapter

There are several avenues for programming the adapter.

To get started on developing solutions with the adapter using Device Cloud, see the Device Cloud, see the Device Cloud product page at www.digi.com/products/cloud/digi-device-cloud.

For details on programming the adapter and retrieving data from it, see the XBee USB Adapter product page on the Digi Developer Community Wiki:

www.digi.com/wiki/developer/index.php/Category:Drop-in_Networking_Products

XBee USB Adapter LEDs and buttons

There is one LED and one button on the end of the adapter opposite the USB connector:

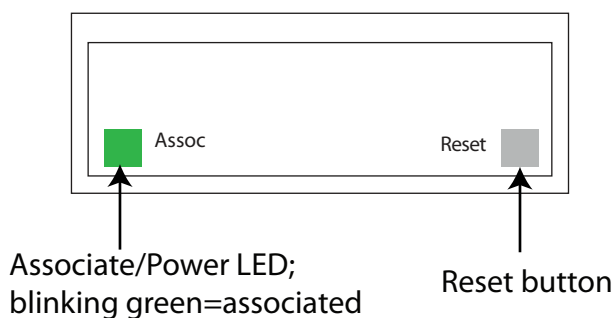

LED / Button	Function
Associate/ Power LED	Indicates the adapter's network association status. This LED functions differently depending on the XBee RF protocol for the product. See XBee Adapters network association status on page 10 for more information.
Reset button	Performs a reset. Use a small non-conductive tool with a blunt end to press gently and hold down button.

XBee Sensor Adapter

Overview of the XBee Sensor Adapter



The XBee Sensor Adapter provides short-range wireless connectivity to Digi Watchport[®] Sensors. Unlike an embedded wireless module, which requires design integration and development time, these off-the-shelf adapters provide instant wireless connectivity to existing Watchport Sensors. All XBee adapters can be used with Digi's gateways for data aggregation and IP connectivity.

Available sensor products

The XBee Sensor Adapter can be used with a variety of Watchport sensors. For a description and list of supported sensors, go to the Digi website.

Power options for the XBee sensor adapter

Depending on adapter model, there are several powering options.

Lithium battery model

This model can be powered by a 3-6VDC external power supply or by 2/3 AA 3.6V lithium batteries and a 1/2 AA boost capacitor. Replacement batteries available for purchase; contact Digi at **952-912-3444** or **877-912-3444**.

Alkaline battery model

This product can be powered by a 9-30VDC external power supply (see the Power requirements rows of the table in [XBee Adapters](#) on page 64) or by batteries. Use 3x1.5V “N” alkaline battery cells. To install batteries, insert a screwdriver in the slots in the side of the adapter case and twist to snap off the cover. Insert the batteries following the polarity diagram on the board.

XBee Sensor Adapter placement recommendations

Isolate the XBee Sensor Adapter from temperature sources other than the one you are measuring. For example, when using it to monitor indoor room temperature, do not place it in direct or indirect sunlight.

For the light sensor, low-Hertz light bulbs, such as fluorescent lamps, can produce inconsistent measuring results. Multiple light samples should be taken to achieve reliable results.

Connection and power for the XBee Sensor Adapter

1. Connect the sensor to the **SENSOR** port of the adapter.
2. Connect the power supply to the adapter or insert batteries.

XBee Sensor Adapter pinouts

The XBee Sensor Adapter uses an industry-standard RJ45 10 pin modular jack. Pin 1 is the leftmost pin and pin numbers increment from left to right.

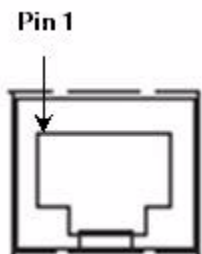

Pinouts for the connector are:

Pin	Function
1	Not used.
2	Not used.
3	Not used.
4	GND.
5	1-wire (sensor) data.
6	+5VDC switched power out.
7	GND.
8	+5VDC switched power out.
9	General-purpose logic input for moisture sensor.
10	Not used.

Software programming and data retrieval for the XBee Sensor Adapter

There are several avenues for programming the XBee Sensor Adapter.

To get started on developing solutions with the XBee Sensor Adapter using Device Cloud, see the Device Cloud, see the Device Cloud product page at www.digi.com/products/cloud/digi-device-cloud.

For details on programming the XBee Sensor Adapter and retrieving data from it using available Python modules, see the topic on the Digi Python Wiki titled **Programming XBee Drop-in Networking Accessories (Adapters, Routers, Sensors)**

www.digi.com/wiki/developer/index.php/Category:Drop-in_Networking_Products

XBee Sensor Adapter LEDs and buttons

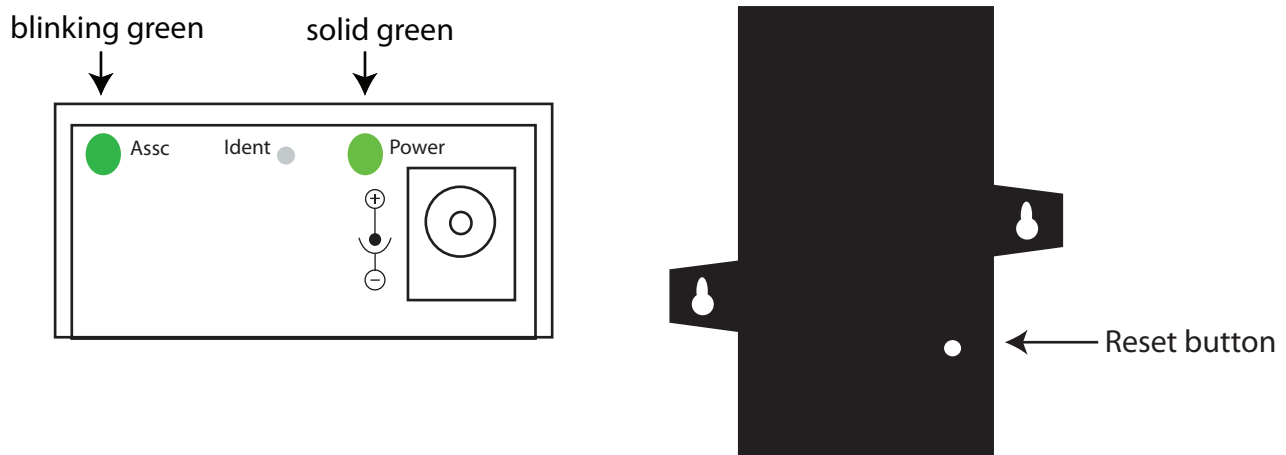

LED/Button	Function
Power LED	Indicates whether power is on. Illuminated only when adapter is connected to external power, not when powered by batteries. Not available in lithium-battery models.
Assc LED	Indicates the adapter's network association status. This LED may function differently depending on the XBee protocol running on your product. See XBee Adapters network association status on page 10 for more information.
Reset Button	Recessed button on underside of the adapter. Performs equivalent of a power-cycle. Use a small non-conductive tool with a blunt end to press gently and hold down button.
Ident Button	Recessed button on power end of the adapter between Assc and Power LEDs. Performs multiple functions for identifying and configuring the adapter in a wireless network. Button presses and actions vary by XBee protocol; see Commissioning and identity behaviors on page 12. Consecutive button presses must occur within 800 milliseconds of each other to perform the desired action.

XStick

Overview of the XStick



The XStick is a USB peripheral module adapter that provides short-range wireless connectivity to an XBee network.

Power requirements for the XStick

The XStick is a USB bus-powered device.

Connection and startup of the XStick

Plug the XStick into the USB connector of a PC, or use a USB extension cable.

The extension cable must be no more than three meters long.

Download and install device driver for the XStick

The XStick requires a device driver, **FT232R**. To download this device driver, go to this web page and select the download appropriate for your operating system:

www.ftdichip.com/Drivers/VCP.htm

<http://www.ftdichip.com/Drivers/VCP.htm>

Software programming and data retrieval for the XStick

There are several avenues for programming the XStick.

To get started on developing solutions with the XStick using Device Cloud, see the Device Cloud, see the Device Cloud product page at www.digi.com/products/cloud/digi-device-cloud.

For details on programming the XStick and retrieving data from it, see the XStick product page on the Digi Developer Community Wiki:

www.digi.com/wiki/developer/index.php/Category:Drop-in_Networking_Products

Unsupported XBee AT Commands for the XStick

The XStick does not support these XBee AT commands:

XStick ZB / ZNet 2.5:

D0, D1, D2, D3, D4, D6, IS, PR, P0, P1, P2, RP, %V, V

XStick 802.15.4:

AV, D0, D1, D2, D3, D4, D5, D6, D7, D8, IA, IC, IO, IR, IS, IT, IU, M0, M1, PR, PT, P0, P1, P2, RP, T0, T1, T2, T3, T4, T5, T6, T7

XStick LEDs and buttons

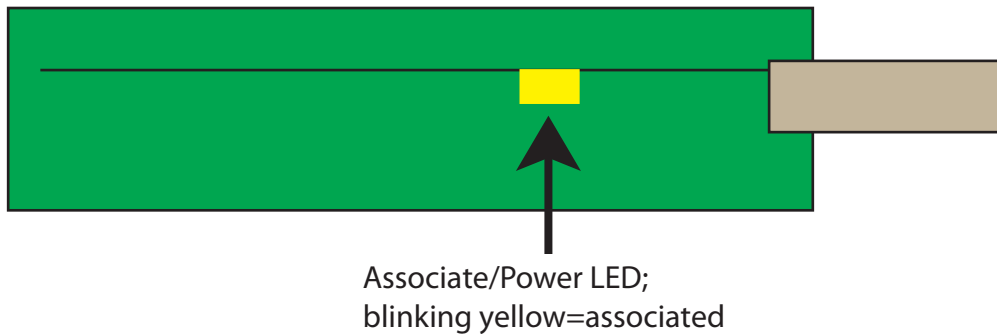

LED/Button	Function
Associate / Power LED	Located inside the unit. Indicates whether the XStick is powered and its network association status. This LED functions differently depending on the XBee RF protocol for the product. See XBee Adapters network association status on page 10 for more information.

XBee Wall Router / Smart Energy Range Extender

Overview of the XBee Wall Router/Smart Energy Range Extender



XBee technology enables low-cost, low-power networking of sensors, controllers and other such devices in self-configuring, self-healing wireless networks. Digi's XBee Wall Router is a small network extender that can be used to create the backbone of a wireless network or to expand the range of a wireless network so that other network devices can seamlessly communicate with one another. The XBee Wall Router can be used in conjunction with any Drop-in Networking Accessory, gateway, or XBee module with a compatible XBee RF protocol, for data aggregation and IP connectivity. The Smart Energy Range Extender is intended for use as a Range Extender device in a Smart Energy network.

Part of Digi's Drop-in Networking solutions, the XBee Wall Router helps to create and/or fortify the infrastructure of a wireless network by simply plugging into standard wall power sockets around a customer facility, creating a multi-path self-healing network. Installation is easy and completely unobtrusive.

The U.S. version of the XBee Wall Router includes a built-in mounting tab, which allows it to be securely screwed into standard wall sockets using the existing mounting screw hole. This prevents accidental unplugging of the repeater and reduces risk of theft or vandalism. The XBee Wall Router is designed primarily to “patch” areas within a wireless network where signal erosion or loss occurs due to distance limitations or air interference. It also serves to create multiple pathways, increasing the redundancy of the mesh communications to ensure maximum network reliability.

In addition to wireless network extension, the XBee Wall Router also includes integrated temperature and light sensors. Customers using ConnectPort X gateways have the ability to retrieve data from these sensors. At this time, the Smart Energy Range Extender does not support data retrieval from its sensors.

Placement recommendations for the XBee Wall Router

Isolate the XBee Wall Router from temperature sources other than the one you are measuring. For example, when using it to monitor indoor room temperature, do not place it in direct or indirect sunlight.

For the light sensor, low-Hertz light bulbs, such as fluorescent lamps, can produce inconsistent measuring results. Multiple light samples should be taken to achieve reliable results.

XBee Wall Router light and temperature sensors

The XBee Wall Router's light sensor is designed to be used in environments of less than or equal to 1200 lux. If the light sensor is exposed to light greater than 1200 lux it causes temperature readings to be inaccurate until the bright light is removed.

Connection and startup for the XBee Wall Router

1. Plug the XBee Wall Router into an outlet.
2. To make sure your XBee Wall Router is properly connected to the XBee network, check the **Associate/Power** LED, as described on page 49.
3. Discover the XBee Wall Router in the XBee network and change configuration settings as needed, as described in [Configuration with a Digi Gateway](#) on page 59.

Connection and startup for the Smart Energy Range Extender

1. Plug the Smart Energy Range Extender into an outlet. Verify that it has power by a flashing **Associate/Power** LED.
2. Register the MAC address and link key (or install code) of the Smart Energy Range Extender with the Coordinator of the Smart Energy network.
3. Set your Smart Energy network to permit joining.
4. Start the Smart Energy Range Extender's join process by pressing the ident button once. Joining may require up to 30 seconds to complete. The Associate/Power LED will continue to flash while the device attempts to join the network.

Note Do not press the ident button within two minutes of the initial join attempt.

5. When the Smart Energy Range Extender has joined the network successfully, the **Associate/Power** LED will be lit and steady.

Operating the Smart Energy Range Extender

1. To allow other devices to join your Smart Energy network via the Smart Energy Range Extender, press the ident button twice.
2. To make a joined Smart Energy Range Extender leave the network, press the ident button four times. The Smart Energy Range Extender will leave the network, attempt to rejoin, then attempt to join a new network. If joining is enabled on a compatible neighboring Smart Energy network when this happens, the Smart Energy Range Extender will join that network.
3. A joined Smart Energy Range Extender checks its connection to the network's Coordinator every 30 seconds. If the connection is lost, the Associate/Power LED will flash.

Software Programming and data retrieval for the XBee Wall Router and the Smart Energy Range Extender

XBee Wall Router

There are several avenues for programming the XBee Wall Router.

To get started on developing solutions with the XBee Wall Router using Device Cloud, see the Device Cloud, see the Device Cloud product page at www.digi.com/products/cloud/digi-device-cloud.

For details on programming the XBee Wall Router and retrieving data from it, see the XBee Wall Router product page on the Digi Developer Community Wiki:

www.digi.com/wiki/developer/index.php/Category:Drop-in_Networking_Products

Smart Energy Range Extender

For details on using the Smart Energy Range Extender, refer to the XBee / XBee PRO SE (Smart Energy) RF Modules User's Guide, available on the Digi website:

www.digi.com/

LEDs, buttons, and integrated sensors

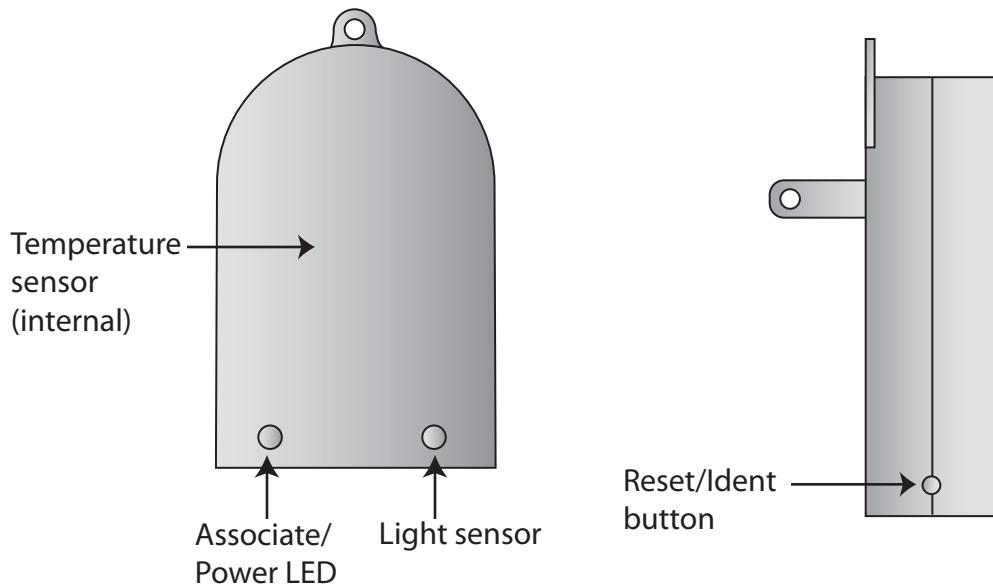

LED/Button	Function
Associate/Power LED	Indicates the XBee Wall Router's network association status. This LED functions differently depending on the XBee RF protocol for the product. See XBee Adapters network association status on page 10 for more information.
Reset/Ident button	<p>Performs a reset and multiple functions for identifying and configuring the XBee Wall Router in a wireless network.</p> <p>Use a small non-conductive tool with a blunt end to press gently and hold down button. Button presses and actions vary by XBee RF protocol; see Commissioning and identity behaviors on page 12.</p> <p>Consecutive button presses must occur within 800 milliseconds of each other to perform the desired action.</p>

XBee Smart Plug

Overview of the XBee Smart Plug



CAUTION! Read all safety information in this section before installing or using the XBee Smart Plug.



XBee technology enables low-cost, low-power networking of sensors, controllers and other devices in self-configuring, self-healing wireless networks. The XBee Smart Plug is an intelligent electrical outlet that can measure and control appliances plugged in via a standard electrical outlet. Part of Digi's Drop-in Networking family, XBee Smart Plug integrates with ConnectPort X gateways to centralize input from multiple XBee Smart Plugs into an energy management solution.

The XBee Smart Plug is intended for use with common household appliances (computer, television, lighting, fan, refrigerator, etc.) that meet the load ratings on the following page. It is not intended for use with products outside the operational specifications in this document or on the product label.

The XBee Smart Plug can measure current consumption from an attached appliance. This information can be communicated to monitor or control the appliance. An application can use this information to determine such things as on/off status, operating range, appliance state (low power mode, idle, etc.), or erratic behavior, to initiate subsequent actions, such as powering off the appliance.

In addition to network extension, the XBee Smart Plug includes an integrated light sensor and two environmental sensors, for temperature and light. Sensor data can be received by using a ConnectPort X gateway with the XBee Smart Plug.

There are two versions of the XBee Smart Plug: one for use in the USA and the other for use in Canada. The U.S. version of the XBee Smart Plug includes a built-in mounting tab, which allows it to be securely screwed into standard wall sockets using the existing mounting screw hole.

XBee Smart Plug safety information



WARNING! XBee Smart Plug is rated for the following loads. All ratings are at 120VAC/60Hz at a maximum ambient temperature of 104° F (40° C). Do not plug in devices that exceed these ratings, either alone or in combination.

Resistive: 120VAC, 8A
Inductive: (0.75 pf): 120VAC, 960VA
Motor: 1/3 HP (7.2 FLA)



WARNING! XBee Smart Plug has an internal fuse that can blow if operating outside the ratings listed above. The fuse is not replaceable and blowing the fuse will void the warranty. A new unit must be purchased.



WARNING! Improper use or installation can cause SERIOUS INJURY, DEATH, or LOSS/DAMAGE OF PROPERTY.



WARNING! To reduce the risk of electric shock, this equipment has a grounding-type plug with a third (grounding) pin. This plug will fit into a grounding-type outlet only. If the plug does not fit into the outlet, contact a qualified electrician to install the proper outlet. Do not change the plug in any way.



WARNING! Install this product in accordance with all national, state, and local electrical codes.



WARNING! This product is for indoor use in dry locations only.

WARNING! This product generates heat. The room in which it is installed must have adequate ventilation or the ability to dissipate heat effectively.



WARNING! This product is not fault tolerant and is not designed, manufactured or intended for any use requiring fail-safe performance in which failure could lead to death, serious personal injury, or severe physical or environmental damage. This includes, but is not limited to, the operation of aircraft or nuclear facilities or for the control of devices that preserve, maintain, or contribute to human or animal safety or life support.



CAUTION! Using this product in a manner outside of normal conditions and other than that described here, opening this product, or modifying it in any way voids your warranty. Digi International Inc. is not liable for any damage incurred because of the misuse or modification of this product.

XBee Smart Plug connection and startup

1. Plug the XBee Smart Plug into an outlet.
2. To make sure the XBee Smart Plug is properly connected to the XBee network, check the Associate/Power LED, as described on page 54.
3. Discover the XBee Smart Plug in the XBee network and change configuration settings as needed, as described in [Configuration with a Digi Gateway](#) on page 59.
4. Plug the appliance you want to control into the user outlet of the XBee Smart Plug.

Note By default, power to the user outlet is disabled. In order to power the attached appliance, the user outlet must be enabled in the device configuration settings, as described in [Configuration with a Digi Gateway](#) on page 59.

XBee Smart Plug operation

LEDs, buttons, and integrated sensors on the XBee Smart Plug



LED / Button sensor	Function
User outlet	<p>Standard AC 110V, 3-prong socket used to power external appliance.</p> <p>Important: Adhere to the product’s load ratings.</p> <p>Power control to the user outlet is configured by the XBee module’s digital I/O channel D4. This channel must be configured as a digital output. By default, power is disabled to the user outlet (indicated by off-state of the outlet LED). To enable power to the outlet, D4 must be set high which in turn will be indicated by the outlet LED glowing.</p>
Current sensor	<p>Detects current draw from user AC socket.</p> <p>The XBee Smart Plug uses a hall-effect current sensor IC to detect RMS current draw from the user controlled outlet. As there is no power factor correction for inductive loads, sensor accuracy is only specified for resistive loads. Current measurements can still be made on inductive loads that fall within the product load rating, but accuracy is not guaranteed.</p>
Light sensor	<p>Ambient light sensor capable of measuring indoor lighting levels.</p> <p>Low-Hertz light bulbs, such as fluorescent lamps, can produce inconsistent measuring results. Multiple light samples should be taken to achieve reliable results.</p>
Temperature sensor	<p>keep commented out for now</p> <p>Isolate the XBee Smart Plug from temperature sources other than the one you are measuring. For example, when using it to monitor indoor room temperature, do not place it in direct or indirect sunlight.</p>

LED / Button sensor	Function
Associate LED (green)	Indicates the XBee Smart Plug's network association status. This LED functions differently depending on the XBee RF protocol for the product. See XBee Adapters network association status on page 10 for more information.
Outlet LED (yellow)	Indicates when the user AC socket is powered.
Reset/Ident button	<p>Performs a reset and multiple functions for identifying and configuring the XBee Smart Plug in a wireless network.</p> <p>Use a small non-conductive tool with a blunt end to press gently and hold down button. Button presses and actions vary by XBee RF protocol; see Commissioning and identity behaviors on page 12. Consecutive button presses must occur within 800 milliseconds of each other to perform the desired action.</p> <p>Consecutive button presses must occur within 800 milliseconds of each other to perform the desired action.</p>

Software programming and data retrieval

There are several avenues for programming the XBee Smart Plug.

To get started on developing solutions with the XBee Smart Plug using Device Cloud, see the Device Cloud, see the Device Cloud product page at www.digi.com/products/cloud/digi-device-cloud.

For details on programming the XBee Smart Plug and retrieving data from it, see the XBee Smart Plug product page on the Digi Developer Community Wiki:

www.digi.com/wiki/developer/index.php/Category:Drop-in_Networking_Products

XBee sensors

Overview of XBee sensors



The XBee Sensor family is a group of XBee-enabled, battery-powered sensors incorporating an XBee module. Part of Digi's Drop-in Networking solutions, XBee Sensors read real-time data from sensors such as temperature, humidity, and light. This data can be retrieved and transmitted through wireless communications in an XBee network infrastructure. Compact size and battery power enable XBee Sensors to be dropped into facilities easily and unobtrusively while providing reliable communications. Applications include building automation, environmental monitoring, security, asset monitoring, and more.

Installation is easy: simply insert batteries, add the XBee Sensor to the XBee network, and configure inputs and outputs, using programming information available on the Digi Developer Community Wiki. Next, mount the device in a desired out-of-the-way location and begin collecting data. XBee Sensors can be used with Digi's gateways, XBee embedded modules, and other XBee accessories to drop-in end-to-end device networks, without the need for a wired network infrastructure.

XBee sensor options

There are currently two XBee Sensor product options available:

- **XBee Sensor /L/T:** Integrated ambient light and temperature sensors

- **XBee Sensor /L/T/H:** Integrated ambient light, temperature, and humidity sensors

Note The maximum sensor reading is 0x3FF. Higher readings are possible, but users should treat all higher readings as 0x3FF.

XBee sensor siting recommendations

Isolate the XBee Sensor from temperature sources other than the one you are measuring. For example, when using it to monitor indoor room temperature, do not place it in direct or indirect sunlight.

For the light sensor, low-Hertz light bulbs, such as fluorescent lamps, can produce inconsistent measuring results. Multiple light samples should be taken to achieve reliable results.

Connection and power for XBee Sensors

1. Insert batteries. Device power is indicated by the green **ASSC** LED on the front panel of the XBee Sensor.
2. Discover the XBee sensor in the XBee network and change configuration settings as needed, as described in [Configuration with a Digi Gateway](#) on page 59.
3. Mount the XBee sensor in the desired location.

Software programming and data retrieval for XBee Sensors

There are several avenues for programming the XBee Sensor.

To get started on developing solutions with the XBee Sensor using Device Cloud, see the Device Cloud, see the Device Cloud product page at www.digi.com/products/cloud/digi-device-cloud.

For details on programming the XBee Sensor and retrieving data from it, see XBee Sensors product page on the Digi Developer Community Wiki:

www.digi.com/wiki/developer/index.php/Category:Drop-in_Networking_Products

Sleep current in XBee Sensors

The following table shows the configuration settings to achieve lowest sleep current. Note that these settings are configured in XCTU.

Configuration settings	Current
Configuration Settings	Current
Default Settings	30uA
Unused I/O pins set to Digital-Out Low	170uA
Internal pull-up resistors disabled	60uA
Internal pull-ups disabled and I/O set to Digital-Out Low	30uA

XBee Sensors LEDs, buttons, and integrated sensors

XBee Sensors have one button and one LED.

XBee Sensor /L/T models have integrated light and temperature sensors.

XBee Sensor /L/T/H models have integrated light, temperature, and humidity sensors.



LED / Button	Function
Associate/Power LED	Indicates power and the XBee Sensor's network association status. This LED functions differently depending on the XBee RF protocol for the product. See XBee Adapters network association status on page 10 for more information.
Reset/Ident Button	Performs a reset and multiple functions for identifying and configuring the XBee Sensor in a wireless network. Use a small non-conductive tool with a blunt end to press gently and hold down button. Button presses and actions vary by XBee RF protocol; see Commissioning and identity behaviors on page 12. Consecutive button presses must occur within 800 milliseconds of each other to perform the desired action.

Configure XBee RF module settings

There are several configurable settings for the XBee RF module in XBee Drop-in Networking Accessories, including the PAN ID, the node identifier or name for the unit, timeout and scanning settings, and others. This chapter shows how to configure these settings, both through a gateway's web interface and in the absence of a gateway using over-the-air (OTA) commands.

For more complete information on these settings, see the manual for the XBee module in your product.

Configuration with a Digi Gateway

Access the Gateway's web interface

1. On the PC, open a web browser such as Internet Explorer.
2. In the browser's address bar, enter the IP address of the gateway. The default IP address is **192.168.1.1**, though the actual address may vary.
3. The home page of the gateway's web interface is displayed. For example:

Digi

ConnectPort X4 Configuration and Management

Home

Help

Home

Getting Started

Tutorial Not sure what to do next? This Tutorial can help.

System Summary

Model:	ConnectPort X4
Ethernet MAC Address:	00:40:9D:37:9F:2B
Ethernet IP Address:	192.168.1.1
Description:	None
Contact:	None
Location:	None
Device ID:	00000000-00000000-00409DFF-FF379F2B

Copyright © 1996-2011 Digi International Inc. All rights reserved.
www.digi.com

View the Gateway and nodes in Your XBee network

1. In the gateway's web interface, select **Administration > System Information** from the menu.

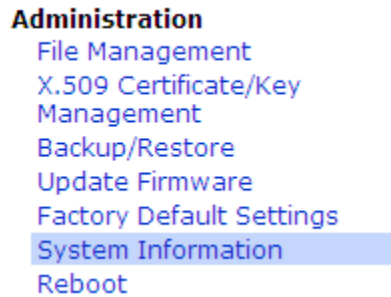

The **System Information** page displays.

2. From the list of System Information links, click **XBee Network**.

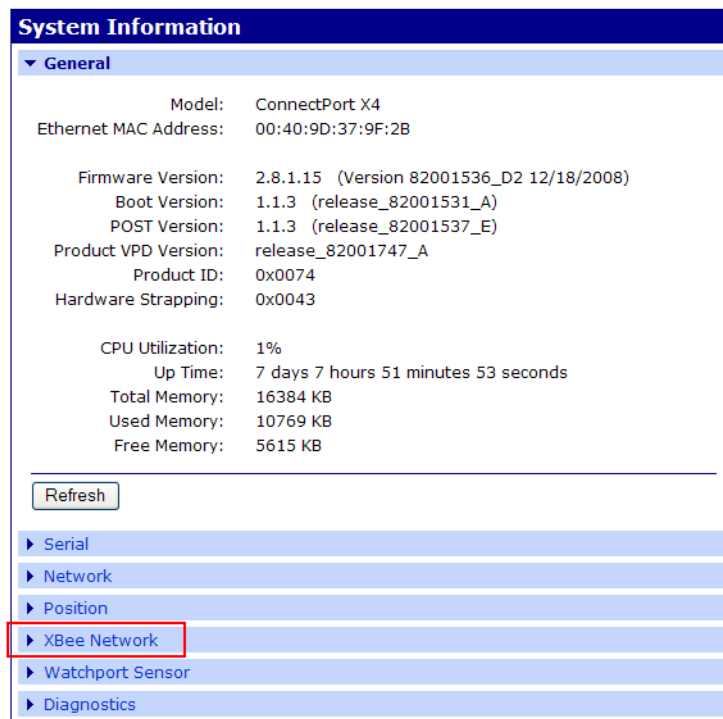

The **XBee Network** page displays It shows several settings for the gateway, followed by the **Network View of the XBee Devices**.

In the **Node Type** column, the descriptors for the nodes can vary by XBee RF protocol. For example, XBee ZB / ZNet 2.5 series products show the XBee module in the gateway as the **coordinator**, and any XBee Drop-in Networking Accessories are as **routers**.

Network View of the XBee Devices

Node ID	Network Address	Extended Address	Node Type	Product Type
[0000]!		00:13:a2:00:40:52:92:26!	coordinator	X4 Gateway
[10a2]!		00:13:a2:00:40:3e:07:68!	router	Unspecified

Clear list before device discovery

Discover XBee Devices

XBee 802.15.4 series products show the XBee module in the gateway as the **coordinator**, and any XBee Drop-in Networking Accessories as **end nodes**.

Network View of the XBee Devices

Node ID	Network Address	Extended Address	Node Type	Product Type
[0000]!		00:13:a2:00:40:30:fb:32!	coordinator	X4 Gateway
[0000]!		00:13:a2:00:40:53:6d:f8!	end node	

Clear list before device discovery

Discover XBee Devices

View and change XBee radio settings as needed

1. In the web interface, go to **Configuration > XBee Network**.

The **XBee Network Configuration** page is displayed. It shows several settings for the gateway, followed by the **Network View of the XBee Devices**. Again, the descriptors for the nodes in the Node Type column can vary by XBee RF protocol. This example is for XBee ZB / ZNet 2.5 series products:

XBee Configuration

▼ Network View of the XBee Devices

Node ID	Network Address	Extended Address	Node Type	Product Type
[0000]!		00:13:a2:00:40:52:92:26!	coordinator	X4 Gateway
[10a2]!		00:13:a2:00:40:3e:07:68!	router	Unspecified

Clear list before performing refresh

Refresh

2. In the list under **Network View of the XBee Devices**, locate your product by its physical address. This address is printed on a label on the bottom of the unit. Click the **Network Address** or **Extended Address** to open the product's settings page.

3. The XBee Network Configuration page displays.

Settings can vary among XBee RF protocols. The settings shown here are for an XBee ZB module.

View and change configuration settings as needed. To apply configuration changes, click **Apply**.

The **Basic radio settings** control basic operation of the XBee module in an XBee network. **Advanced radio settings** control behavior of the XBee module at a more detailed level. Generally, these settings can be left at their defaults.

For complete settings and descriptions, refer to the Product Manual for the XBee or XBee-PRO module in your product.

To apply configuration changes, click **Apply**.



CAUTION! Changing the PAN ID may make your XBee product inaccessible.

Note If you assign a Node Identifier, to view it, go to **Configuration > XBee Network** and click **Refresh**. The new name is displayed in the **Node Identifier** field.

Configuration without a Gateway

If you are not configuring your Drop-in Networking Accessory with a ConnectPort X gateway, the XBee module in the accessory must be configured using OTA commands. There are two methods of initiating OTA commands to a target XBee module:

- Using the OTA graphical user interface of XCTU, a software tool for configuring XBee modules. In XCTU, this interface is referred to as Remote Configuration.
- Using the Remote Command API frame suited to your XBee RF protocol.

Important: serial communications disabled on XBee analog and digital I/O adapters

For the XBee Analog and Digital I/O Adapters, the XBee firmware disables the XBee module's serial communications functionality, so that the pins normally used for serial communications can instead be used for additional I/O functionality. As a result, once an XBee module has been loaded with the firmware image specific to the XBee Analog or Digital I/O Adapters, the XBee module can no longer be configured using XCTU, the XBee serial API, or local AT commands.

The only way to configure these adapters is by using the **Ident** or **Ident/Reset** commissioning and identification button (see [Commissioning and identity behaviors](#) on page 12 for description) and OTA commands. You can do this by using a ConnectPort gateway or XCTU, or by using the remote command API of another serial-enabled module associated to the same network.

Using XCTU's OTA user interface

XBee modules can also be configured over-the-air using XCTU and its Remote Configuration function. In this process, an XBee module on a base device, such as a USB interface board, is connected to a PC running XCTU. The XBee module on the base device communicates with the XBee module on a remote device, allowing you to read, write, and restore configuration settings in the remote XBee module.

Configuring XBee modules remotely through XCTU requires additional hardware and software. Contact [Digi Technical Support](#) for details.

Using the Remote Command API frame

For information on using the API mode directly to initiate remote commands, see the manual for the XBee or XBee-PRO module in your product.

Locating OTA configuration commands for your product

To determine which OTA commands are necessary for configuring your XBee device, refer to the product page for your device on the Digi DeveloperCommunityWiki.

www.digi.com/wiki/developer/index.php/Main_Page

Hardware specifications

XBee Adapters

Hardware Specifications for XBee Adapters

Specification		Value
Environmental	Operating temperature	XBee RS-232 Adapter, XBee RS-485 Adapter, XBee Analog Adapter, XBee Digital I/O Adapter, XBee USB Adapter: Lithium battery models: -40° to 158° F (-40° C to 70° C) Alkaline battery models: 0.4° to 131° F (-18° C to 55° C) External power supply: The temperature range of the UL/C-UL Listed power supply must be at a minimum of 40° to 158° F (-40° C to 70° C) to meet the allowed ambient temperature range for XBee Adapters. If a power supply with an ambient rating of less than 158° F (70° C) is used, then the allowed ambient temperature range of the XBee Adapter is reduced to the rating of the power supply chosen.
	Relative humidity	5% to 95% (non-condensing)

Specification		Value
Power requirements	DC power input	<p>XBee RS-232 Adapter, XBee RS-485 Adapter, XBee Analog Adapter, XBee Digital I/O Adapter:</p> <p>External power supply varies by model:</p> <p>Lithium battery model:</p> <p>3.7-6VDC external power supply with locking-barrel connector.</p> <p>Alkaline battery model:</p> <p>UL /c-UL Listed ITE or Class II external power supply, with output rated between 9 to 30VDC, with a current rating of 300mA or greater; locking-barrel connector of 2.1mm x 5.5mm, center is positive.</p>
	N-cell batteries	<p>XBee RS-232 Adapter, XBee RS-485 Adapter, XBee Analog Adapter, XBee Digital I/O Adapter:</p> <p>3x1.5V “N” alkaline battery cells</p>
	Lithium batteries	<p>XBee RS-232 Adapter, XBee RS-485 Adapter, XBee Analog Adapter, XBee Digital I/O Adapter:</p> <p>2/3 AA 3.6V lithium battery and a 1/2 AA boost capacitor pack.</p>
	Bus-powered	<p>XBee USB Adapter:</p> <p>Bus powered: +5V from USB bus</p> <p>Power consumption during normal operation:</p> <p>XBee: 70 mA</p> <p>XBee-PRO: 70 mA (Rx) and 250 mA (Tx)</p> <p>Power consumption during suspend mode: XBee and XBee-PRO: 200 uA</p>
Dimensions	XBee RS-232 Adapter, XBee RS-485 Adapter, XBee Analog Adapter, XBee Digital I/O Adapter:	
	Length	3.6 in (9.14cm)
	Width	1.9 in (4.82 cm)
	Height	1.2 in (3.04 cm)
	Weight	2.29 oz (65.0 g)
	XBee USB Adapter:	
	Length	2.87 in (7.29 cm)
	Width	1.80 in (4.57 cm)
	Height	0.83 in (2.10 cm)
Weight	1.60 oz (45.36 g)	

XStick 802.15.4 (XStick1)

Specification	Value	
Environmental	Operating temperature	-40° to 185° F (-40°C to 85°C)
	Relative humidity	5% to 95% (non-condensing)
Power Requirements	Supply voltage	5V from USB port of PC
	Operating current (transmit)	XStick 802.15.4: 64mA
	Operating current (receive)	XStick 802.15.4: 64mA
	Power-down current	Do not put the XStick 802.15.4 into sleep mode.
Dimensions	Width	0.7 in (1.78 cm)
	Height	0.4 in (1.02 cm)
	Length	1.8 in (4.57 cm)
	Weight	0.265 oz (7.5 g)
RF Operation	Operating frequency band	2.4GHz ISM
	Antenna options	Internal antenna only
RF Performance	Indoor/urban range	XStick 802.15.4: 15m
	Outdoor RF line-of-sight Range	XStick 802.15.4: 40m
	Transmit power output (nominal 25°C)	XStick 802.15.4: 1mW (0dBm) Peak Conducted (FCC & Industry Canada)
	RF data rate	250kbps
	Serial interface data rate (software selectable)	1200 bps-1M bps
	Receiver sensitivity	-90dBm
Networking and Security	Supported network topologies	Point-to-point, Point-to-multipoint, Peer-to-peer, DigiMesh
	Number of channels (software selectable)	16
	Addressing options	PAN, Channel, and address

The XStick 802.15.4 is a radio transceiver, and has received these agency approvals:

Certifications	
UnitedStates (FCC Part 15.247)	FCC ID: XBee 802.15.4 series: MCQ-XSTICK1
IndustryCanada (IC)	IC: XBee 802.15.4 series: 1846A-XSTICK1
Europe (CE)	Yes
Japan (TELEC)	No

The XStick 802.15.4 (XStick1) has a maximum radiated RF power of -2.27 dBm Equivalent Isotropically Radiated Power (EIRP).

The operating frequencies of the XStick 802.15.4 (XStick1) are one of the 16 channels on the following frequencies:

2405, 2410, 2415, 2420, 2425, 2430, 2435, 2440, 2445, 2450, 2455, 2460, 2465, 2470, 2475, 2480

XStick ZigBee (XStick2)

Specification	Value	
Environmental	Operating temperature	-40° to 185° F (-40°C to 85°C)
	Relative humidity	5% to 95% (non-condensing)
Power Requirements	Supply voltage	5V from USB port of PC
	Operating current (transmit)	XStick ZB 2.5: 51mA
	Operating current (receive)	XStick ZB 2.5: 47mA
	Power-down current	Do not put the XStick ZigBee into sleep mode.
Dimensions	Width	0.7 in (1.78 cm)
	Height	0.4 in (1.02 cm)
	Length	1.8 in (4.57 cm)
	Weight	0.265 oz (7.5 g)
RF Operation	Operating frequency band	2.4GHz ISM
	Antenna options	Internal antenna only
RF Performance	Indoor/urban range	XStick ZB: 20m
	Outdoor RF line-of-sight Range	XStick ZB: 50m
	Transmit power output (nominal 25°C)	XStick ZB: 2.8 mW (4.5 dBm) Peak Conducted (FCC & Industry Canada)
	RF data rate	250kbps
	Serial interface data rate (software selectable)	1200 bps-1M bps
	Receiver sensitivity	-90dBm

Specification	Value	
Networking and Security	Supported network topologies	ZigBee
	Number of channels (software selectable)	16
	Addressing options	PAN, Channel, and address

The XStick ZigBee is a radio transceiver, and has received these agency approvals:

Certifications	
UnitedStates (FCC Part 15.247)	FCC ID: XStick ZB: MCQ-XSTICK2
IndustryCanada (IC)	IC: XStick ZB:1846A-XSTICK22
Europe (CE)	No
Japan (TELEC)	Yes

XBee Wall Router / Smart Energy Range Extender

Specification	Value	
Environmental	Operating temperature	-4° F to 167° F (-20° C to 75° C)
	Relative humidity	5% to 95% (non-condensing)
Power requirements	AC power input	Universal AC input (85VAC to 265VAC)
Maximum power	-2.27 dBm Equivalent Isotropically Radiated Power (EIRP)	
Locking mechanism	Secure unit to electrical outlet using center outlet screw (U.S. only)	
Dimensions	Length	2.87 in (7.30 cm)
	Width	2.87 in (5.0 cm)
	Height	1.37 in (3.50 cm)
	Weight	2.50 oz (70.87 g)
RF operation	Operating frequency band	2.4GHz ISM
	Antenna options	Internal antenna
Frequencies	5 MHz channel spacing, beginning at 2405 MHz and ending at 2480 MHz	
RF performance	Indoor/Urban range	Up to 300 ft (90 m)
	Outdoor RF line-of-sight range	Up to 2 miles (3200 m)
	Transmit power output	63 mW (18 dBm)
	RF data rate	250,000 bps
	Receiver sensitivity	-102 dBm (1% PER)

Specification		Value
Temperature sensor	Range	-4° F to 158° F (-20° C to 70° C)
	Accuracy	+/- 2° C
Ambient light sensor	Range of spectral bandwidth	360 to 970 nm (similar to human eye)
	Wavelength of peak sensitivity	570 nm
	Environment conditions	Not to exceed 1200 lux or will cause inaccurate temperature readings

XBee Wall Router regulatory information

Europe

The XBee Wall Router is certified for use in several European countries. For information, visit <http://www.digi.com/resources/certifications>.

If the XBee Wall Router is incorporated into a product, the manufacturer must ensure compliance of the final product with articles 3.1a and 3.1b of the RE Directive (Radio Equipment Directive). A Declaration of Conformity must be issued for each of these standards and kept on file as described in the RE Directive (Radio Equipment Directive).

Furthermore, the manufacturer must maintain a copy of the XBee Wall Router user manual documentation and ensure the final product does not exceed the specified power ratings, antenna specifications, and/or installation requirements as specified in the user manual. If any of these specifications are exceeded in the final product, a submission must be made to a notified body for compliance testing to all required standards.

OEM labeling requirements

The 'CE' marking must be affixed to a visible location on the OEM product.

CE labeling requirements

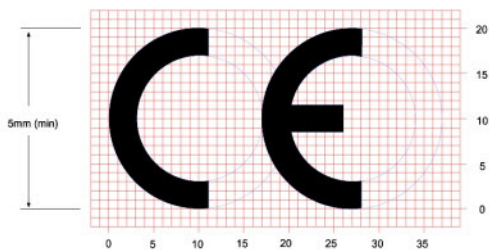

The CE mark shall consist of the initials “CE” taking the following form:

- If the CE marking is reduced or enlarged, the proportions given in the above graduated drawing must be respected.
- The CE marking must have a height of at least 5mm except where this is not possible on account of the nature of the apparatus.
- The CE marking must be affixed visibly, legibly, and indelibly.

Declarations of Conformity

Digi has issued Declarations of Conformity for the XBee Wall Router concerning emissions, EMC, and safety. For more information, see <http://www.digi.com/resources/certifications>.

Radio Equipment Directive

If the XBee Wall Router is incorporated into a product, the manufacturer must ensure compliance of the final product with articles 3.1a and 3.1b of the RE Directive (Radio Equipment Directive). A Declaration of Conformity must be issued for each of these standards and kept on file as described in the RE Directive (Radio Equipment Directive).

Important note

Digi customers assume full responsibility for learning and meeting the required guidelines for each country in their distribution market. Refer to the radio regulatory agency in the desired countries of operation for more information.

XBee Smart Plug

Specification		Value
Environmental	Operating temperature	-4° F to 104° F (-20° C to 40° C)
	Relative humidity	5% to 95% (non-condensing)
Power requirements	AC power input	120VAC, 50/60 Hz
	Load rating	Resistive: 120VAC, 8A Inductive: (0.75 pf): 120VAC, 960VA Motor: 1/3 HP (7.2 FLA)
Dimensions	Length	3.07 in (9.40 cm)
	Width	2.42 in (6.14 cm)
	Height	1.47 in (3.73 cm)
	Weight	0.26 lb (.12 kg)
RF operation	Operating frequency band	2.4GHz ISM
	Antenna options	Internal antenna
RF performance	Indoor/urban range	Up to 100 ft (30 m)
	RF line-of-sight range	Up to 100 ft (30 m)
	Transmit power output	50 mW (+17 dBm)
	RF data rate	250kbp
	Serial interface data rate (software selectable)	1200 bps-1M bps
	Receiver sensitivity	-102dBm (1% PER)

Specification		Value
Networking and security	Supported network topologies	Point-to-point Point-to-multipoint Peer-to-peer ZigBee
	Number of channels (software selectable)	16 - 5 MHz channels (Direct Sequence Spread Spectrum)
	Addressing options	PAN, Channel, and address
Certifications		The XBee Smart Plug is a radio transceiver, and has received these agency approvals: UL/cUL 244A, Third Edition, "Standard for Solid State Controls for Appliances" (PENDING) FCC Part 15, Class B (PENDING) EN55022 Class B, EN 55024 (PENDING) RoHS Compliant to RoHS I and II.
	United States (FCC Part 15.247)	FCC ID: MCQ-XBEEPRO2
	Industry Canada (IC)	IC: 1846A-XBEEPRO2

Integrated sensors for XBee Smart Plug

Sensor	Specification	Value
Current sensor	Sensor method	Detects current draw from user AC socket
	Range	0 - 8A Reading can vary by up to 200mA
	Output error	100mA
Ambient light sensor	Range of spectral bandwidth	360 to 970 nm (similar to human eye)
	Wavelength of peak sensitivity	570 nm

XBee sensors

Specification		Value
Environmental	Operating temperature	-64.4° F to 131° F (-18° C to +55° C)
	Relative humidity	5% to 95% (non-condensing)
Power requirements	AC power input	Alkaline Batteries 3 x 1.5V Alkaline battery cells

Specification		Value
Dimensions	Length	2.70 in (6.85 cm)
	Width	2.50 in (6.35 cm)
	Height	1.30 in (3.30 cm)
	Weight	0.35 lb (0.158 kg) with batteries installed, 0.20 lb (0.091 kg) without batteries installed
RF operation	Operating frequency band	2.4GHz ISM
	Antenna options	Internal antenna
RF performance	Indoor/urban range	Up to 133 ft (40 m)
	Outdoor RF line-of-sight range	Up to 400 ft (120 m)
	Transmit power output	1.25 mW (+1 dBm) / 2 mW (+3 dBm) boost mode
	RF data rate	250kbp
	Receive sensitivity (1% PER)	-97 dBm (-98 dBm boost mode)
Certifications		XBee Sensors have received these agency approvals: FCC Part 15, Class B •EN55022 Class B, EN 55024 RoHS Compliant

Integrated sensors for XBee Sensors

Sensor	Specification	Value
Temperature sensro	Range	-64.4° F to 131° F (-18° C to +55° C)
	Accuracy	+/- 2° C
Ambient light sensor	Range of spectral bandwidth	360 to 970 nm (similar to human eye)
	Wavelength of peak sensitivity	570 nm
	Luminance range	10 to 1000 lux +/- 20%
Humidity sensor	Range	5 to 95% RH
	Interchangeability	+/- 5% RH (0% RH to 59% RH) +/- 8%RH (60% RH to 95% RH)
	Accuracy	+/- 3.5% RH

Note The ambient light sensor is a simple “light intensity” sensor. It is not intended to be used by applications requiring luminous intensity measurements.

Sleep current

Sensor	Sleep Current	XCTU Settings
Light, Temperature, Humidity	190uA	Pull-up resistors enabled
	30uA	Pull-up resistors disabled Any unused I/O pins set to digital low

Safety statements

Class I division 2, groups A, B, C, D hazardous location

 **CAUTION!** XBee Drop-in Networking Accessories are intended for use in ordinary locations only.

 **CAUTION!** The device and any leads for the device may **not** be extended into a Hazardous Location.

 **CAUTION!** This device has not been evaluated for use in wet locations or near combustible liquids, fumes, or vapors.

Lithium battery safety precaution

 **CAUTION!** XBee adapter and sensor products have no user-serviceable parts and are intended to be opened by qualified service personnel only.

 **CAUTION!** Danger of explosion exists if lithium batteries are replaced incorrectly. Replacement must be done by qualified service personnel, and only with the same or equivalent battery type recommended by the manufacturer. Dispose of unused batteries according to the manufacturer's instructions.

XBee Smart Plug installation safety

 **CAUTION!** Read all safety information in XBee Smart Plug chapter before installing or using the XBee Smart Plug.
